



Leading Media Products

Manufacturing



Manufacturing

North America



CONTENTS

GENERAL MANUFACTURING APPLICATIONS

<i>Item Level Labeling</i>	
Duratran S	3
Duratran Pro Label.....	3
INdelible	4
<i>Work In Process (WIP)</i>	
Duratran II Label	5
Duratran II Tag	5
Duratherm III Label.....	6
Duratherm II Tag	6
<i>Rack, Shelf, and Bin Labeling</i>	
Duratran S Film Label	7
Duratran Pro Label.....	7
INdelible	8
<i>Tote / RPC Labels</i>	
Duratherm S Label.....	8
Duratran Pro Label.....	9
INdelible	9
INdelible HP.....	10
RFID - INdelible HP	10
<i>Asset Tracking</i>	
INdelible	11
INdelible HP.....	11
Duratran Pro Tag	12
<i>Lock-Out / Tag-Out</i>	
Duratran Pro Tag	12
<i>Shipping / In-Transit Visibility</i>	
Duratherm II Paper	13
Duratherm III Linerless Label	14
Duratran II Paper.....	15
RFID Duratran II Paper.....	16
<i>Pick Ticket / Packing Slip</i>	
Duratherm II Paper Receipt.....	16
Duratherm II 5-mil Paper Tag	17
Duratherm II 7-mil Paper Tag	17
<i>Thermal Transfer Ribbons</i>	
ThermaMAX 1000 Wax Ribbons.....	18
ThermaMAX 2000 Mid-Range Ribbons	18
ThermaMAX 3000 Resin Ribbons	18

CHEMICAL INDUSTRY APPLICATIONS

<i>GHS Drum Labeling</i>	
Duratran S	19
INdelible HP (BS5609 / IMDG Compliant).....	19
Syntran.....	20
Duratran S	20

<i>Other Drum Labeling</i>	
INdelible	21
<i>Bulk Dry Goods Labeling</i>	
Duratran II Label (for paper-based packaging)	22
Syntran Label (for woven plastic packaging)	22

AUTOMOTIVE INDUSTRY APPLICATIONS

<i>Component Labeling</i>	
INdelible	23
INdelible HP.....	23
Duratran Pro Tag	24
<i>Reusable Compliance Totes</i>	
Duratran S Tight Removable.....	24
<i>Paint Mask Labeling</i>	
INdelible Paint Mask.....	25
<i>Kanban</i>	
Duratran II Tag	25
Duratherm II Tag	26
<i>Flame-Retardant Sew-In Material</i>	
26	
<i>Tamper-Evident Label</i>	
INdelible VOID	27
Syntran.....	27
<i>Retail Tire Label</i>	
INTact HP.....	27

ELECTRONICS INDUSTRY APPLICATIONS

<i>Component & PCB Manufacturing</i>	
Top-Side - INdelible	28
<i>Wafer Manufacture (Clean Room)</i>	
INdelible Clean	28
Duratran Clean	29
<i>Name Plates / Agency Labels</i>	
INdelible	29
<i>Wiring Harness</i>	
Duratran Synthetic Tag	30
Duratran Pro Tag	30
INTact Label	31
INdelible Label	31

APPENDIX

Direct Thermal vs. Thermal Transfer	32
Free Printhead Replacement Program	32
Application Briefs	33

GENERAL MANUFACTURING APPLICATIONS *Item Level Labeling*

Duratran S

A 3-mil thick polypropylene thermal transfer label at an attractive price point. The matte face stock offers excellent print quality and moisture resistance; recommended for up to six months outdoor exposure.

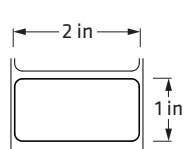

E25754

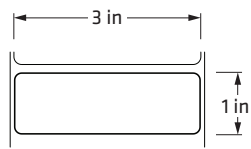

E25755

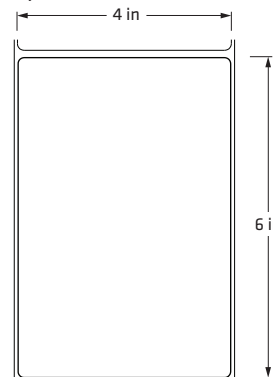

E25743

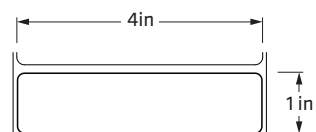

E25756

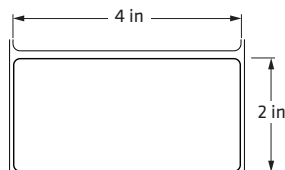

E25742

Size	ID	OD	Part Number	Printer Configuration	Qty/ Roll	Rolls/ Ctn	Ctn Weight	Stock/ MTO	PC41/PF8-0.5" Ribbon	PC43t/PF8t-1" Ribbon	PD/PM/PX Ribbon
2"x1"	1.5"	5"	E25754	Desktop	2702	8	17	MTO	12042504	12232311	n/a
3"x1"	1.5"	5"	E25755	Desktop	2702	8	25	MTO	12043204	12233111	n/a
4"x1"	1.5"	5"	E25756	Desktop	2702	8	34	MTO	12044304	12234012	n/a
4"x2"	3"	8.38"	E25742	Industrial	2,823	4	25	MTO	n/a	n/a	12234118
4"x6"	3"	8.38"	E25743	Industrial	979	4	25	MTO	n/a	n/a	12234118

Duratran Pro Label

A durable, high-quality polyolefin thermal transfer label. Exhibits good tear resistance and moisture resistance, as well as moderate temperature and chemical resistance.

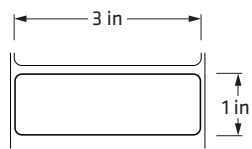

E02202

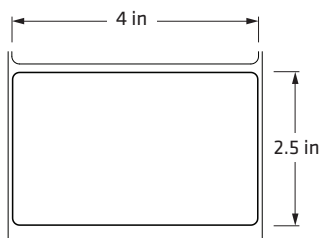

E02204

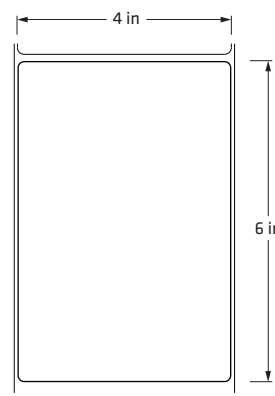

E03444

Size	ID	OD	Part Number	Printer Configuration	Qty/ Roll	Rolls/ Ctn	Ctn Weight	Stock/ MTO	PC41/PF8-0.5" Ribbon	PC43t/PF8t-1" Ribbon	PD/PM/PX Ribbon
3"x1"	1.5"	5"	E02202	Industrial	4888	8	38	Stock	n/a	n/a	12233018
4"x2.5"	3"	8.38"	E02204	Industrial	2,095	4	27	Stock	n/a	n/a	12234118
4"x6"	3"	8.38"	E03444	Industrial	897	4	27	Stock	n/a	n/a	12234118

Desktop



Industrial



Mobile



INdelible

A high-gloss, top-coated polyester label with exceptional print quality. Excellent tear, smear and abrasion resistance; highly moisture and heat resistant. Product is UL and cUL recognized when printed with Intermec ThermaMAX 3202 ribbons. Also available in clear and silver face stocks. For self-strip applications, 4-mil face stocks are also available.

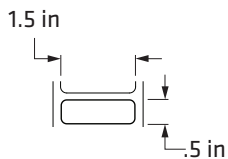

E25745

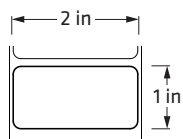

E22233

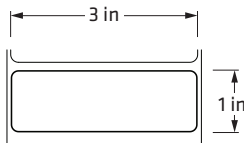

E25746

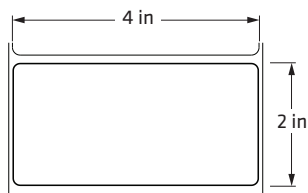

E25747

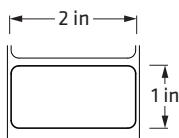

E10164

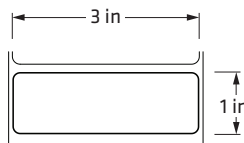

E23068

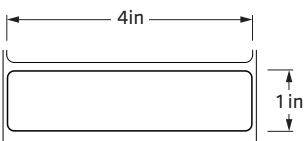

E25732

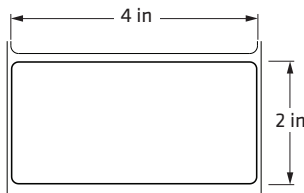

E23222

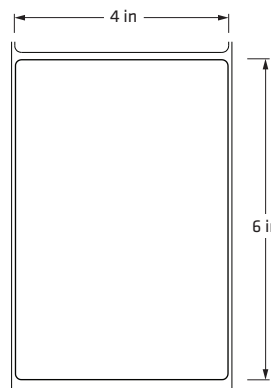

E25733

Size	ID	OD	Part Number	Printer Configuration	Qty/ Roll	Rolls/ Ctn	Ctn Weight	Stock/ MTO	PC41/PF8-0.5" Ribbon	PC43t/PF8t-1" Ribbon	PD/PM/PX Ribbon
1.5"x0.5"	1.5"	5"	E25745	Desktop	2702	8	10	Stock	13042504	13632111	n/a
2"x1"	1.5"	5"	E22233	Desktop	2702	8	12	Stock	13633136	13633111	n/a
3"x1"	1.5"	5"	E25746	Desktop	2702	4	9	Stock	13633136	13633111	n/a
4"x2"	1.5"	5"	E25747	Desktop	1430	4	12	Stock	13044304	13634012	n/a
2"x1"	3"	8.38"	E10164	Industrial	5333	8	12	Stock	n/a	n/a	13632018
3"x1"	3"	8.38"	E23068	Industrial	5333	4	12	Stock	n/a	n/a	13633018
4"x1"	3"	8.38"	E25732	Industrial	5333	4	12	Stock	n/a	n/a	13634118
4"x2"	3"	8.38"	E23222	Industrial	2823	8	51	Stock	n/a	n/a	13634118
4"x6"	3"	8.38"	E25733	Industrial	979	4	25	Stock	n/a	n/a	13634118



Duratran II Label

A top-coated thermal transfer paper that demonstrates excellent print quality with both the TMX1407 and TMX2202 ribbons. This product is recommended where moderate abrasion, heat or sunlight are present.

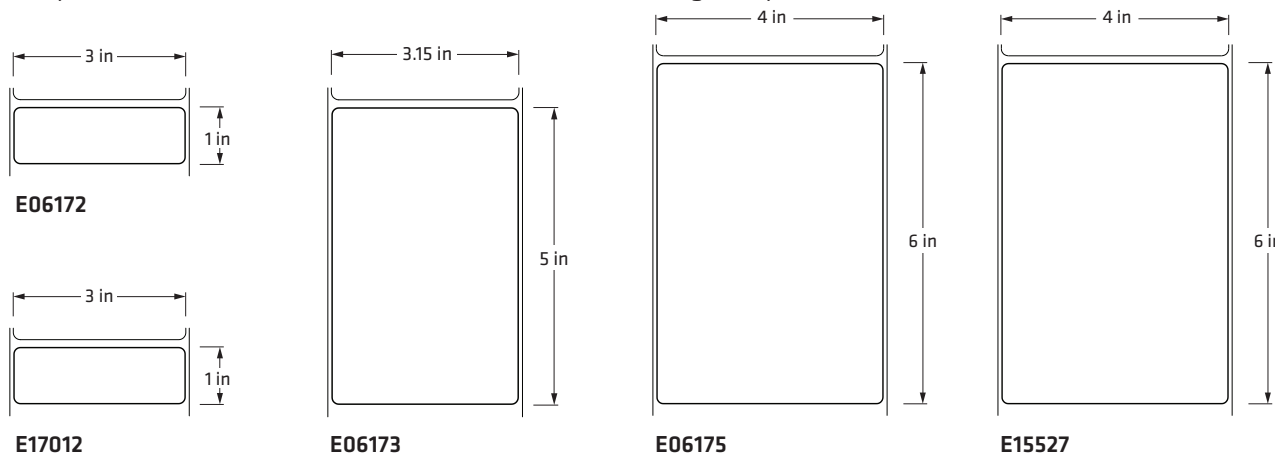

Size	ID	OD	Part Number	Printer Configuration	Qty/ Roll	Rolls/ Ctn	Ctn Weight	Stock/ MTO	PC41/PF8-0.5" Ribbon	PC43t/PF8t-1" Ribbon	PD/PM/PX Ribbon
3"x1"	3"	8.38"	E06172	Industrial	5,333	4	16	Stock	n/a	n/a	11233018
3.15"x5"	3"	8.38"	E06173	Industrial	1170	4	18	Stock	n/a	n/a	11234118
4"x6"	3"	8.38"	E06175	Industrial	979	4	22	Stock	n/a	n/a	11234118
3"x1"	1.5"	5"	E17012	Desktop	2702	8	16	Stock	11043304	11233011	n/a
4"x6"	1.5"	5"	E15527	Desktop	496	8	22	Stock	11044304	11234012	n/a

Duratran II Tag

A 7-mil paper tag that provides excellent print quality and is recommended for most general-use applications where exposure to chemicals and moisture is not anticipated. This tag is compatible with TMX1407 and TMX2202 ribbons.

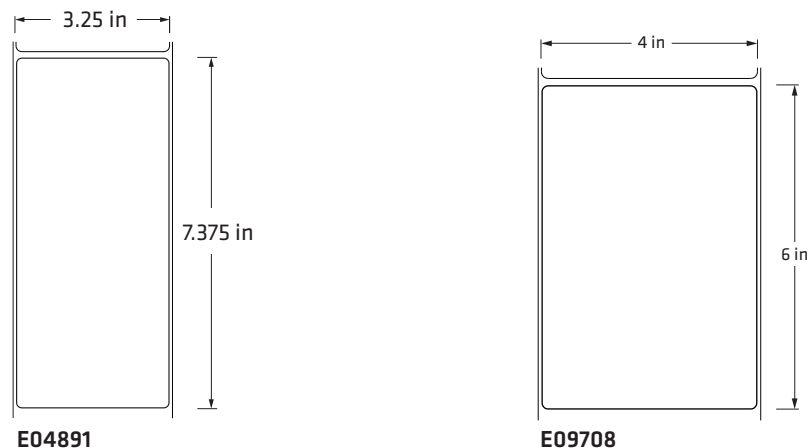

Size	ID	OD	Part Number	Printer Configuration	Qty/ Roll	Rolls/ Ctn	Ctn Weight	Stock/ MTO	PC41/PF8-0.5" Ribbon	PC43t/PF8t-1" Ribbon	PD/PM/PX Ribbon
3.25"x7.375"	3"	8.38"	E04891	Industrial	813	8	42	Stock	n/a	n/a	11234118
4"x6"	3"	8.38"	E09708	Industrial	1000	4	26	Stock	n/a	n/a	11234118

Desktop



Industrial



Mobile



Duratherm III Label

A top-coated direct thermal paper that provides enhanced durability for applications where humidity and surface abrasion are a concern.

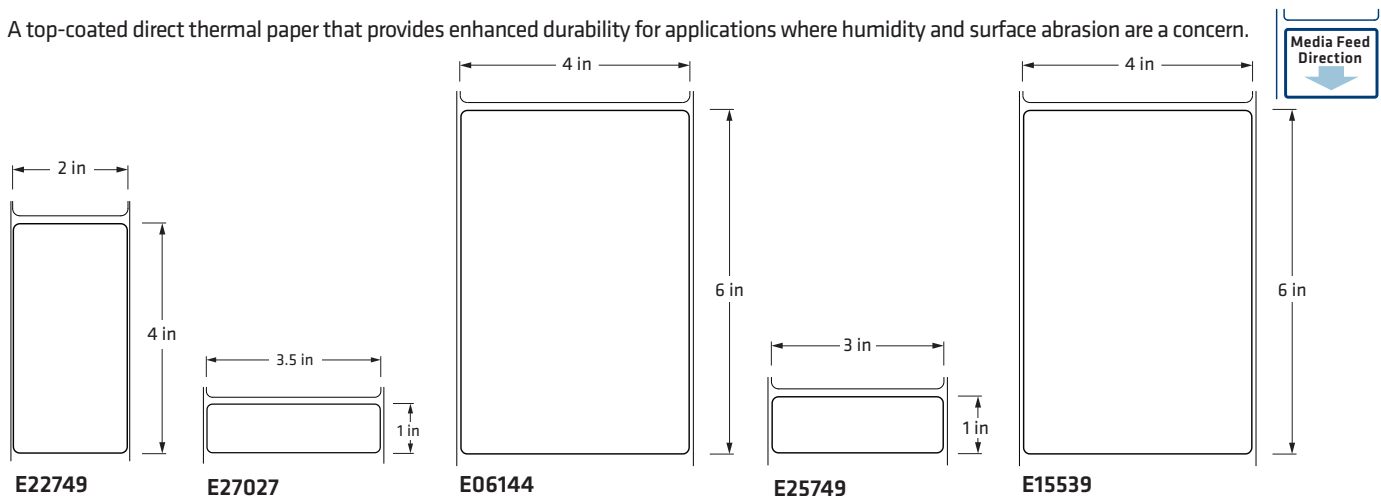

Size	ID	OD	Part Number	Printer Configuration	Qty/ Roll	Rolls/ Ctn	Ctn Weight	Stock/ MTO	PC41/PF8-0.5" Ribbon	PC43t/PF8t-1" Ribbon	PD/PM/PX Ribbon
2"x4"	3"	8.38"	E22749	Industrial	1,454	8	24	Stock	n/a	n/a	n/a
3.5"x1"	3"	8.38"	E27027	Industrial	6000	8	44	MTO	n/a	n/a	n/a
4"x6"	3"	8.38"	E06144	Industrial	979	4	24	Stock	n/a	n/a	n/a
3"x1"	1.5"	5"	E25749	Desktop	2702	8	18	Stock	n/a	n/a	n/a
4"x6"	1.5"	5"	E15539	Desktop	496	8	24	Stock	n/a	n/a	n/a

Duratran Tag

A 7-mil paper tag that provides excellent print quality and is recommended for most general-use applications where exposure to chemicals and moisture is not anticipated. This tag is compatible with TMX1407 and TMX2202 ribbons.

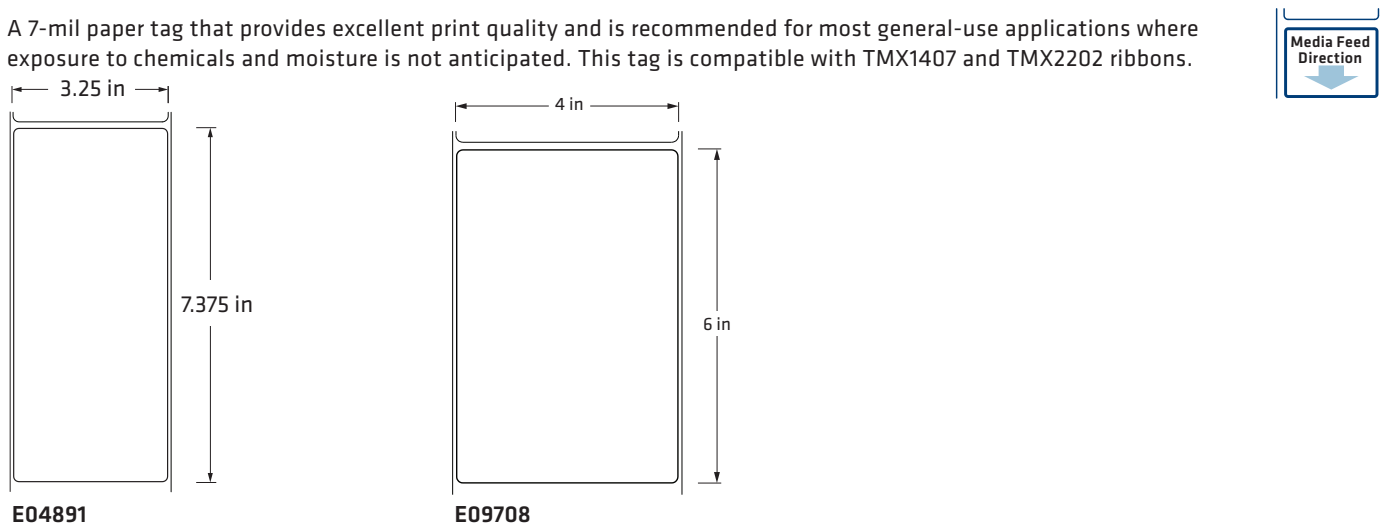

Size	ID	OD	Part Number	Printer Configuration	Qty/ Roll	Rolls/ Ctn	Ctn Weight	Stock/ MTO	PC41/PF8-0.5" Ribbon	PC43t/PF8t-1" Ribbon	PD/PM/PX Ribbon
3.25"x7.375"	3"	8.38"	E04891	Industrial	813	8	42	Stock	n/a	n/a	11234118
4"x6"	3"	8.38"	E09708	Industrial	1000	4	26	Stock	n/a	n/a	11234118

Desktop



Industrial



Mobile



GENERAL MANUFACTURING APPLICATIONS *Rack, Shelf, and Bin Labeling*

Duratran S Film Label

A 3-mil thick polypropylene thermal transfer label at an attractive price point. The matte face stock offers excellent print quality and moisture resistance; recommended for up to six months outdoor exposure.

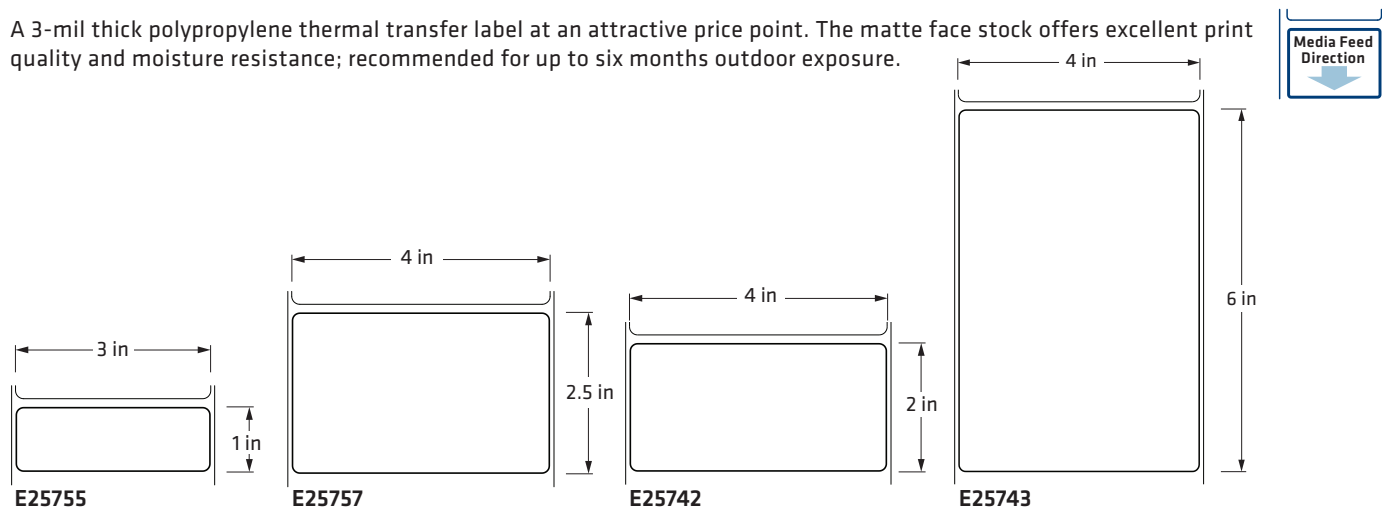

Size	ID	OD	Part Number	Printer Configuration	Qty/ Roll	Rolls/ Ctn	Ctn Weight	Stock/ MTO	PC41/PF8-0.5" Ribbon	PC43t/PF8t-1" Ribbon	PD/PM/PX Ribbon
3"x1"	1.5"	5"	E25755	Desktop	2702	8	17	MTO	12043204	12233111	n/a
4"x2.5"	1.5"	5"	E25757	Desktop	1158	8	17	MTO	12044304	12234012	n/a
4"x2"	3"	8.38"	E25742	Industrial	2,823	4	25	MTO	n/a	n/a	12234118
4"x6"	3"	8.38"	E25743	Industrial	979	4	25	MTO	n/a	n/a	12234118

Duratran Pro Label

A durable, high-quality polyolefin thermal transfer label. Exhibits good tear resistance and moisture resistance, as well as moderate temperature and chemical resistance.

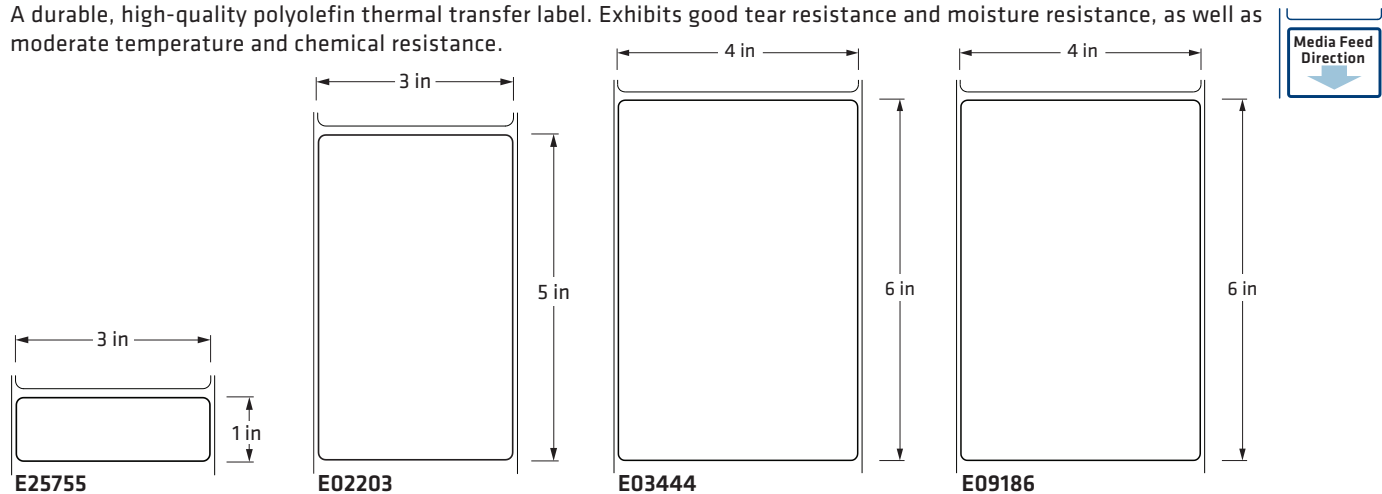

Size	ID	OD	Part Number	Printer Configuration	Qty/ Roll	Rolls/ Ctn	Ctn Weight	Stock/ MTO	PC41/PF8-0.5" Ribbon	PC43t/PF8t-1" Ribbon	PD/PM/PX Ribbon
3"x1"	3"	8.38"	E02202	Industrial	4,888	8	38	Stock	n/a	n/a	12233018
3"x5"	3"	8.38"	E02203	Industrial	1,073	8	38	Stock	n/a	n/a	12233018
4"x6"	3"	8.38"	E03444	Industrial	897	4	26	Stock	n/a	n/a	12234118
4"x6" (Removable)	3"	8.38"	E09186	Industrial	897	4	26	Stock	n/a	n/a	12234118

Desktop



Industrial



Mobile



GENERAL MANUFACTURING APPLICATIONS *Rack, Shelf, and Bin Labeling*

Indelible

A high-gloss, top-coated polyester label with exceptional print quality. Excellent tear, smear and abrasion resistance; highly moisture and heat resistant. Product is UL and cUL recognized when printed with Intermec ThermaMAX 3202 ribbons. Also available in clear and silver face stocks. For self-strip applications, 4-mil face stocks are also available.

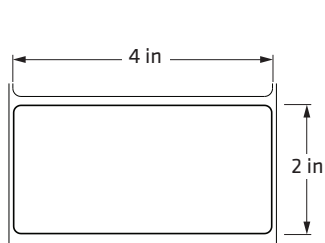

E25747

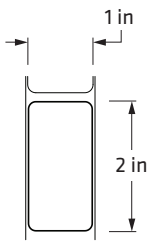

E23067

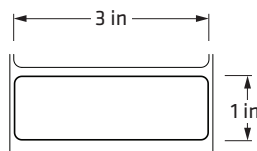

E23068

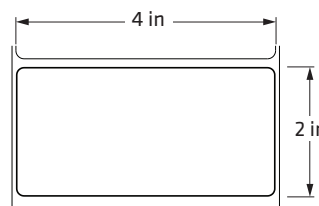

E23222

Size	ID	OD	Part Number	Printer Configuration	Qty/ Roll	Rolls/ Ctn	Ctn Weight	Stock/ MTO	PC41/PF8-0.5" Ribbon	PC43t/PF8t-1" Ribbon	PD/PM/PX Ribbon
4"x2"	1.5"	5"	E25747	Desktop	1,430	4	24	Stock	13044304	11234012	n/a
1"x2"	3"	8.38"	E23067	Industrial	2,823	4	8	Stock	n/a	n/a	13632018
3"x1"	3"	8.38"	E23068	Industrial	5,333	4	19	Stock	n/a	n/a	13633018
4"x2"	3"	8.38"	E23222	Industrial	2823	8	19	Stock	n/a	n/a	13634118

Tote / RPC Labels

Duratherm S Label

A top-coated direct thermal film employing an all-temperature adhesive perfectly suited for ambient and refrigerated environments.

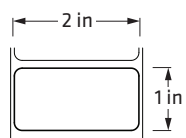

E25764

Size	ID	OD	Part Number	Printer Configuration	Qty/ Roll	Rolls/ Ctn	Ctn Weight	Stock/MTO
2"x1"	0.75"	2.6"	E25764	Mobile	506	32	17	Stock



Duratran Pro Label

A durable, high-quality polyolefin thermal transfer label. Exhibits good tear resistance and moisture resistance, as well as moderate temperature and chemical resistance.

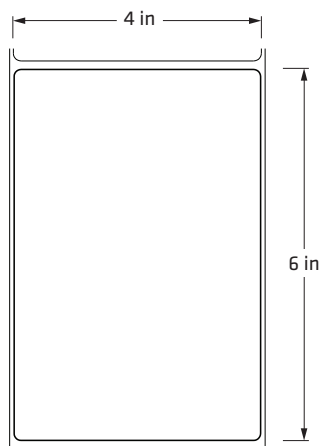

E03444

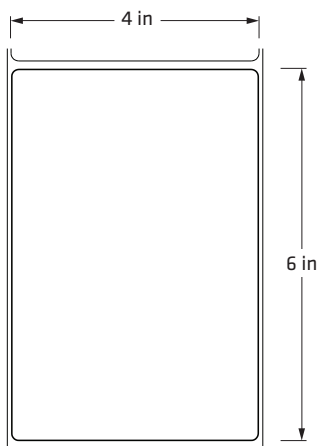

E09186

Size	ID	OD	Part Number	Printer Configuration	Qty/ Roll	Rolls/ Ctn	Ctn Weight	Stock/ MTO	PC41/PF8-0.5" Ribbon	PC43t/PF8t-1" Ribbon	PD/PM/PX Ribbon
4"x6"	3"	8.38"	E03444	Industrial	897	4	27	Stock	n/a	n/a	12234118
4"x6" (Removable)	3"	8.38"	E09186	Industrial	897	8	53	Stock	n/a	n/a	12234118

INdelible

A high-gloss, top-coated polyester label with exceptional print quality. Excellent tear, smear and abrasion resistance; highly moisture and heat resistant. Product is UL and cUL recognized when printed with Intermec ThermaMAX 3202 ribbons. Also available in clear and silver face stocks. For self-strip applications, 4-mil face stocks are also available.

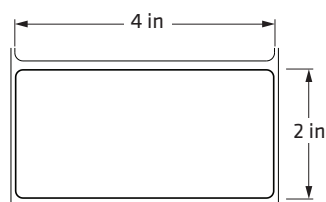

E23222

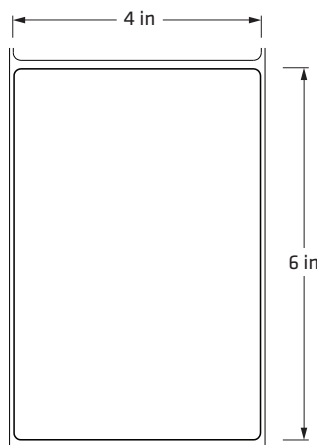

E25733

Size	ID	OD	Part Number	Printer Configuration	Qty/ Roll	Rolls/ Ctn	Ctn Weight	Stock/ MTO	PC41/PF8-0.5" Ribbon	PC43t/PF8t-1" Ribbon	PD/PM/PX Ribbon
4"x2"	3"	8.38"	E23222	Industrial	2823	8	51	Stock	n/a	n/a	13634118
4"x6"	3"	8.38"	E25733	Industrial	979	4	27	Stock	n/a	n/a	13634118

Desktop



Industrial



Mobile



INdelible HP

A high-gloss, top-coated polyester label with exceptional print quality. High performance, heavy coat weight adhesive develops a positive, secure bond even on contaminated or rough surfaces. Excellent tear, smear and abrasion resistance; highly moisture and heat resistant.

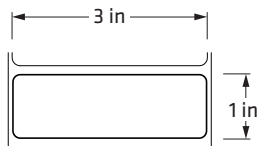

E27277

Size	ID	OD	Part Number	Printer Configuration	Qty/ Roll	Rolls/ Ctn	Ctn Weight	Stock/ MTO	PC41/PF8-0.5" Ribbon	PC43t/PF8t-1" Ribbon	PD/PM/PX Ribbon
3"x1"	3"	8.38"	E27277	Industrial	5,333	4	21	Stock	n/a	n/a	13634118

RFID - INdelible HP

A high-gloss, top-coated polyester label with exceptional print quality. High performance, heavy coat weight adhesive develops a positive, secure bond even on contaminated or rough surfaces. Excellent tear, smear and abrasion resistance; highly moisture and heat resistant. RFID Smart-Label products meet the ISO 18000-6C/EPC Global Gen 2 specification with 128 bits of EPC memory allocation. Intermec's Smart Labels are optimized for use in the PM43 and PM4i printer/encoder. (Configurations compatible with other non-Intermec printers are available as custom items.)

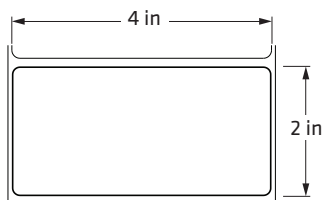

ILR00245

Size	ID	OD	Part Number	Printer Configuration	Qty/ Roll	Rolls/ Ctn	Ctn Weight	Stock/ MTO	PC41/PF8-0.5" Ribbon	PC43t/PF8t-1" Ribbon	PD/PM/PX Ribbon
4"x2"	3"	8.38"	ILR00245	Industrial	1,410	2	21	MTO	n/a	n/a	13634118



Indelible

A high-gloss, top-coated polyester label with exceptional print quality. Excellent tear, smear and abrasion resistance; highly moisture and heat resistant. Product is UL and cUL recognized when printed with Intermec ThermaMAX 3202 ribbons. Also available in clear and silver face stocks. For self-strip applications, 4-mil face stocks are also available.

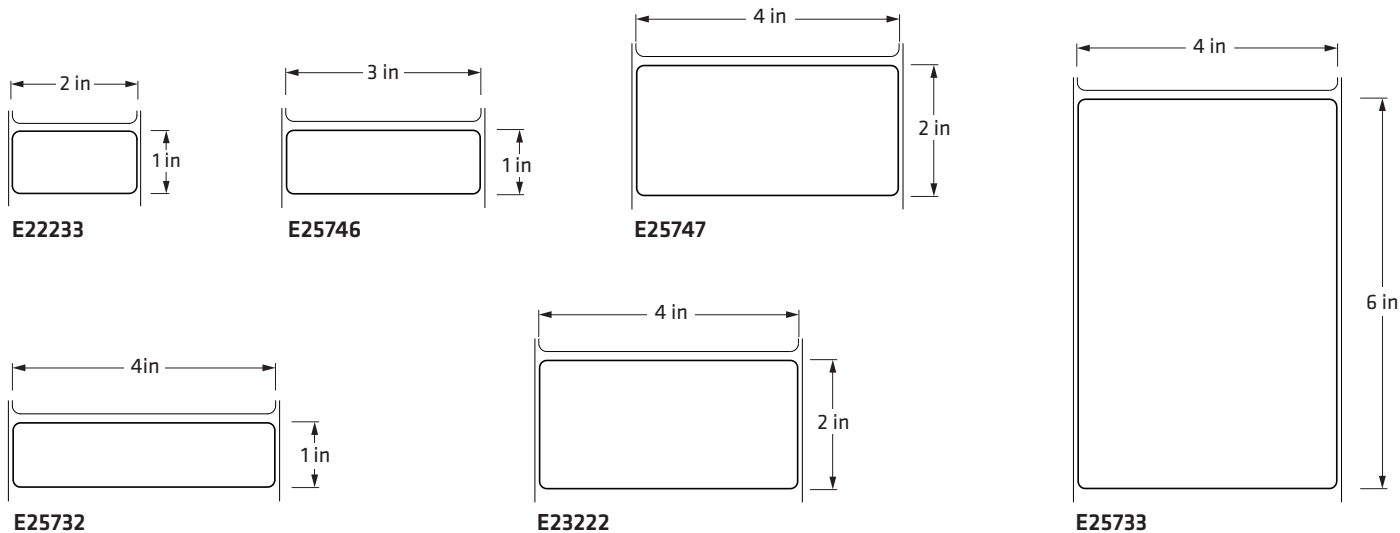

Size	ID	OD	Part Number	Printer Configuration	Qty/ Roll	Rolls/ Ctn	Ctn Weight	Stock/ MTO	PC41/PF8-0.5" Ribbon	PC43t/PF8t-1" Ribbon	PD/PM/PX Ribbon
2"x1"	1.5"	5"	E22233	Desktop	2702	8	10	Stock	13042504	13632111	n/a
3"x1"	1.5"	5"	E25746	Desktop	2702	4	12	Stock	13633136	13633111	n/a
4"x2"	1.5"	5"	E25747	Desktop	1430	4	12	Stock	13044304	13634012	n/a
4"x1"	3"	8.38"	E25732	Industrial	5,333	4	25	Stock	n/a	n/a	13634118
4"x2"	3"	8.38"	E23222	Industrial	2823	8	51	Stock	n/a	n/a	13634118
4"x6"	3"	8.38"	E25733	Industrial	979	4	51	Stock	n/a	n/a	13634118

Indelible HP

A high-gloss, top-coated polyester label with exceptional print quality. High performance, heavy coat weight adhesive develops a positive, secure bond even on contaminated or rough surfaces. Excellent tear, smear and abrasion resistance; highly moisture and heat resistant.

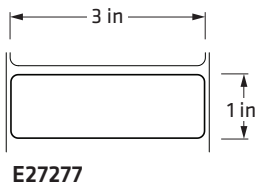

Size	ID	OD	Part Number	Printer Configuration	Qty/ Roll	Rolls/ Ctn	Ctn Weight	Stock/ MTO	PC41/PF8-0.5" Ribbon	PC43t/PF8t-1" Ribbon	PD/PM/PX Ribbon
3"x1"	3"	8.38"	E27277	Industrial	5333	4	21	Stock	n/a	n/a	13633018



Duratran Pro Tag

A premium performance polyethylene tag with excellent tear resistance. Excellent choice when attaching with thin gauge wire or when staples are used.

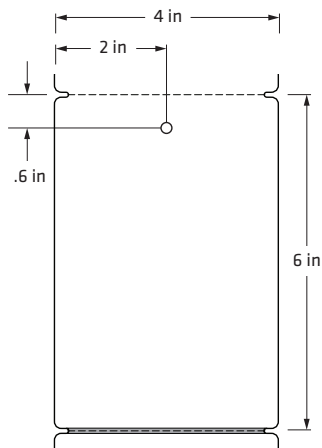

E12982

Size	ID	OD	Part Number	Printer Configuration	Qty/ Roll	Rolls/ Ctn	Ctn Weight	Stock/ MTO	PC41/PF8-0.5" Ribbon	PC43t/PF8t-1" Ribbon	PD/PM/PX Ribbon
4"x6"	3"	8.38"	E12982	Industrial	916	4	23	Stock	n/a	n/a	12234118

Lock-Out / Tag-Out

Duratran Pro Tag

A premium performance polyethylene tag with excellent tear resistance. Excellent choice when attaching with thin gauge wire or when staples are used.

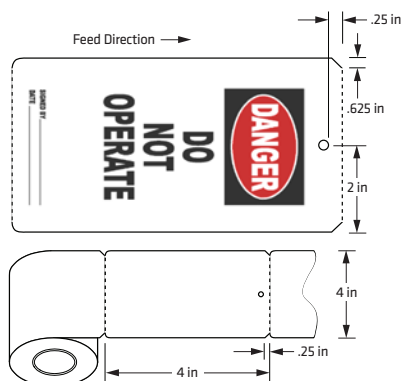

E23543

Size	ID	OD	Part Number	Printer Configuration	Qty/ Roll	Rolls/ Ctn	Ctn Weight	Stock/ MTO	PC41/PF8-0.5" Ribbon	PC43t/PF8t-1" Ribbon	PD/PM/PX Ribbon
4"x7.5"	3"	8.38"	E23543	Industrial	730	8	46	Stock	n/a	n/a	12234118



Duratherm II Paper

A non-top-coated direct thermal paper that offers high quality, cost-effective printing. This material is recommended for most general-use applications where exposure to chemicals and moisture is not anticipated.

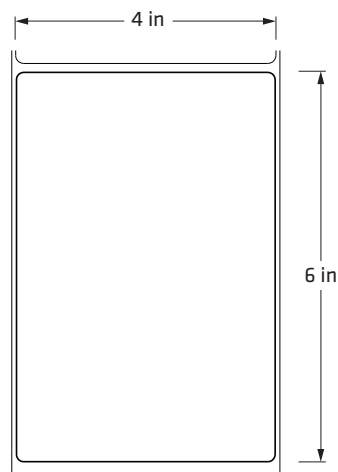

E25726

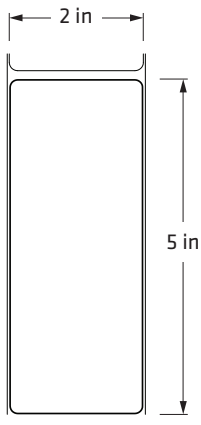

E23470

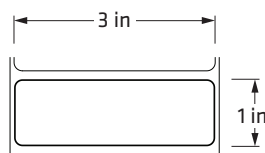

E10192

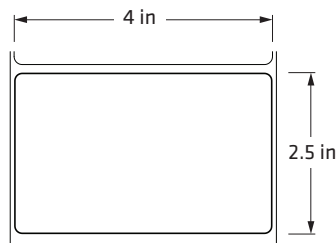

E25735

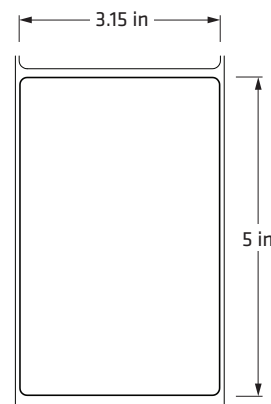

E01384

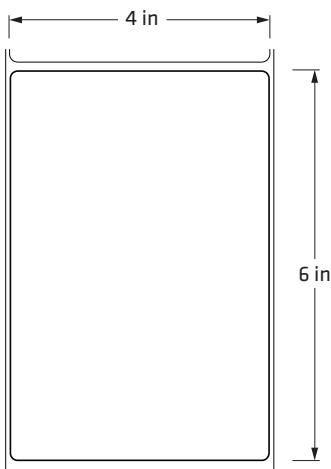

047164

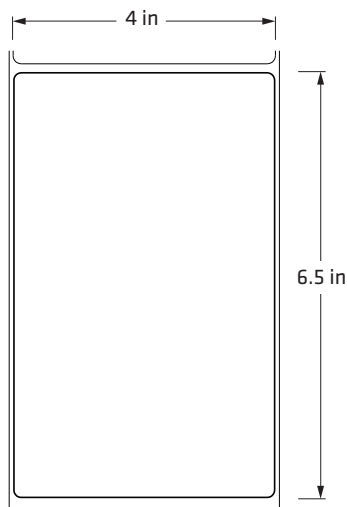

047165

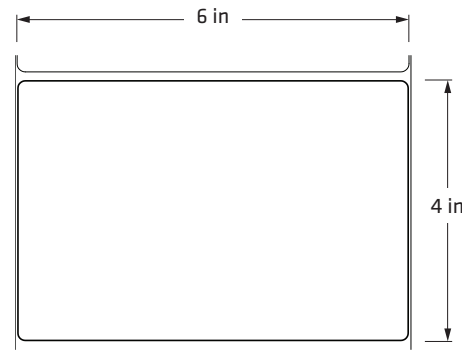

E12400

Size	ID	OD	Part Number	Printer Configuration	Qty/ Roll	Rolls/ Ctn	Ctn Weight	Stock/ MTO	PC41/PF8-0.5" Ribbon	PC43t/PF8t-1" Ribbon	PD/PM/PX Ribbon
4"x6"	1.5"	5"	E25726	Desktop	496	8	17	Stock	n/a	n/a	n/a
2"x5"	3"	8.38"	E23470	Industrial	1,170	8	25	Stock	n/a	n/a	n/a
3"x1"	3"	8.38"	E10192	Industrial	5,333	8	18	Stock	n/a	n/a	n/a
3.15"x5"	3"	8.38"	E01384	Industrial	1,170	4	19	Stock	n/a	n/a	n/a
4"x2.5"	3"	8.38"	E25735	Industrial	2,285	4	25	Stock	n/a	n/a	n/a
4"x6"	3"	8.38"	047164	Industrial	979	4	24	Stock	n/a	n/a	n/a
4"x6.5"	3"	8.38"	047165	Industrial	905	4	24	Stock	n/a	n/a	n/a
6"x4"	3"	8.38"	E12400	Industrial	1,454	4	36	Stock	n/a	n/a	n/a

Desktop



Industrial



Mobile



Duratherm III Linerless Label

A self-wound adhesive label that provides excellent print quality and durability without the need for a liner. By removing the liner, the roll capacity increases and there's no need to dispose of the liner. Product employs tight removable adhesive well-suited for labeling corrugated surfaces.

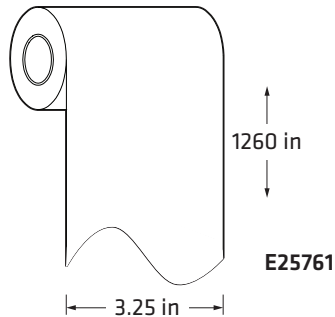
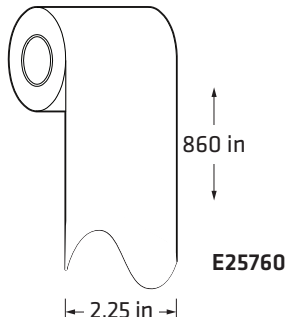

Size	ID	OD	Part Number	Printer Configuration	Qty/ Roll	Rolls/ Ctn	Ctn Weight	Stock/MTO
2.25"x860"	0.75"	2.25"	E25760	Mobile	n/a	50	20	MTO
3.25"x1260"	0.75"	2.6"	E25761	Mobile	n/a	50	24	MTO

Duratran II Paper

A top-coated thermal transfer paper that demonstrates excellent print quality with both the TMX1407 and TMX2202 ribbons. This product is recommended where moderate abrasion, heat or sunlight are present.

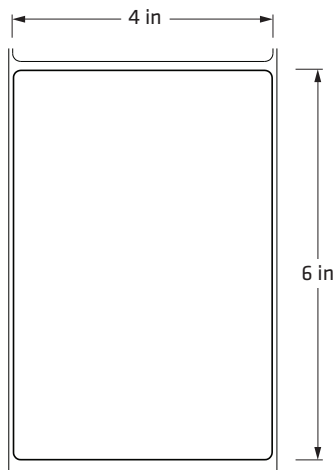

E15527

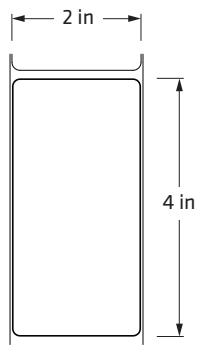

E25879

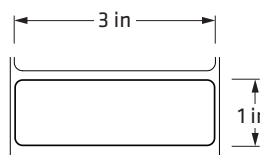

E06172

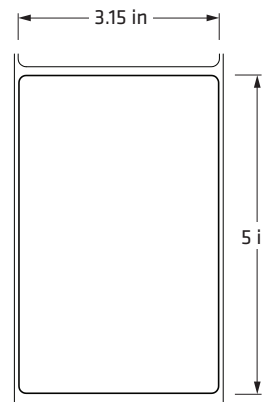

E06173

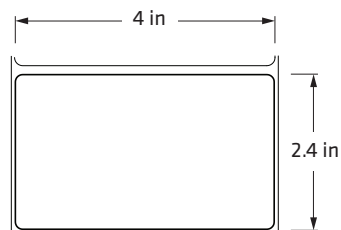

E06174

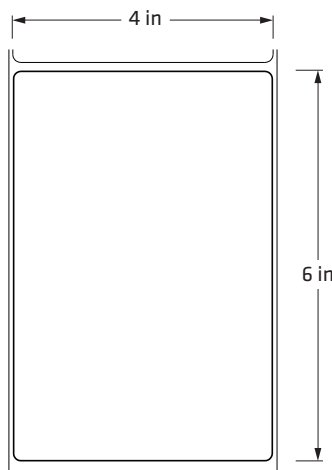

E06175

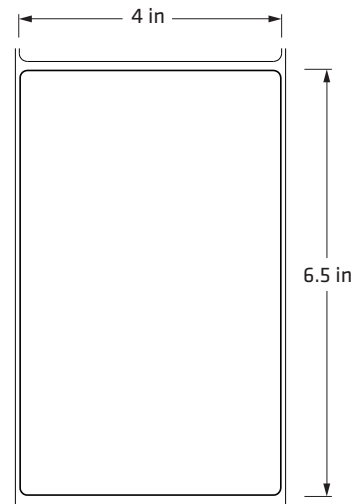

E06176

Size	ID	OD	Part Number	Printer Configuration	Qty/ Roll	Rolls/ Ctn	Ctn Weight	Stock/ MTO	PC41/PF8-0.5" Ribbon	PC43t/PF8t-1" Ribbon	PD/PM/PX Ribbon
4"x6"	1.5"	5"	E15527	Desktop	496	8	21	Stock	11044304	11234012	n/a
2"x4"	3"	8.38"	E25879	Industrial	1,454	8	22	Stock	n/a	n/a	11232018
3"x1"	3"	8.38"	E06172	Industrial	5,333	4	20	Stock	n/a	n/a	11233018
3.15"x5"	3"	8.38"	E06173	Industrial	1,170	4	21	Stock	n/a	n/a	11234118
4"x2.4"	3"	8.38"	E06174	Industrial	2,400	4	24	Stock	n/a	n/a	11234118
4"x6"	3"	8.38"	E06175	Industrial	979	4	24	Stock	n/a	n/a	11234118
4"x6.5"	3"	8.38"	E06176	Industrial	905	4	24	Stock	n/a	n/a	11234118

Desktop



Industrial



Mobile



RFID Duratran II Paper

These labels employ the Duratran II paper label stock with an RFID inlay. RFID Smart-Label products meet the ISO 18000-6C/EPC Global Gen 2 specification with 128 bits of EPC memory allocation. Intermec's Smart Labels are optimized for use in the PM43 and PM4i printer/encoder as shown. (Configurations compatible with other non-Intermec printers are available as custom items.)

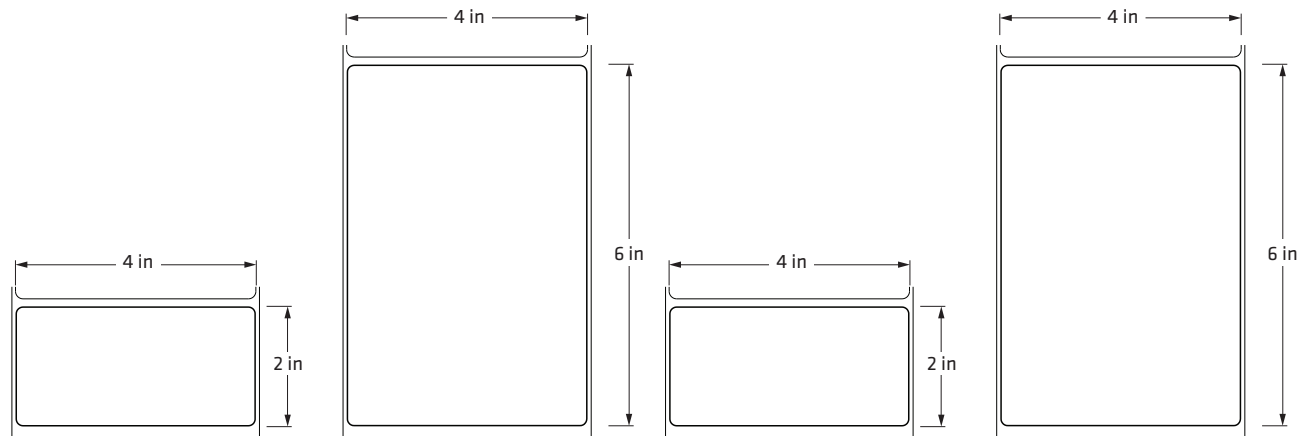

ILR00154 (PM4i)

ILR00146 (PM4i)

ILR00254 (PM43)

ILR00255 (PM43)

Size	ID	OD	Part Number	Printer Configuration	Qty/ Roll	Rolls/ Ctn	Ctn Weight	Stock/ MTO	PC41/PF8-0.5" Ribbon	PC43t/PF8t-1" Ribbon	PD/PM/PX Ribbon
4"x2"	3"	8.38"	ILR00154 (PM4i)	Industrial	1,410	2	15	Stock	n/a	n/a	11234118
4"x6"	3"	8.38"	ILR00146 (PM4i)	Industrial	490	4	8	Stock	n/a	n/a	11234118
4"x2"	3"	8.38"	ILR00254 (PM43)	Industrial	1,410	2	15	Stock	n/a	n/a	11234118
4"x6"	3"	8.38"	ILR00255 (PM43)	Industrial	490	4	8	Stock	n/a	n/a	11234118

Pick Ticket / Packing Slip

Duratherm II Paper Receipt

An uncoated direct thermal paper that provides excellent print quality, well-suited for use in most general applications.

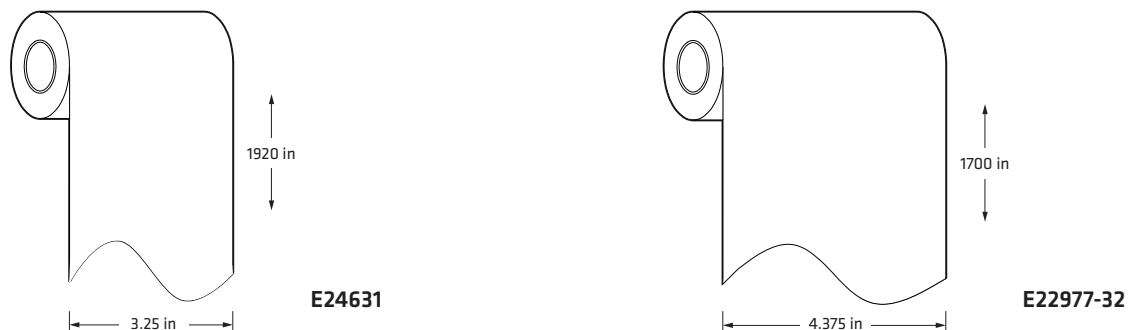

E24631

E22977-32

Size	ID	OD	Part Number	Printer Configuration	Qty/ Roll	Rolls/ Ctn	Ctn Weight	Stock/MTO
3.25"x1920"	0.75"	2.6"	E24631	Mobile	n/a	50	16	MTO
4.375"x1700"	0.75"	2.6"	E22977-32	Mobile	n/a	32	20	Stock

Desktop



Industrial



Mobile



Duratherm II 5-mil Paper Tag

A non-top-coated direct thermal paper that offers high quality, cost-effective printing for mobile printing applications. This material is recommended for most general-use applications where exposure to chemicals and moisture is not anticipated.

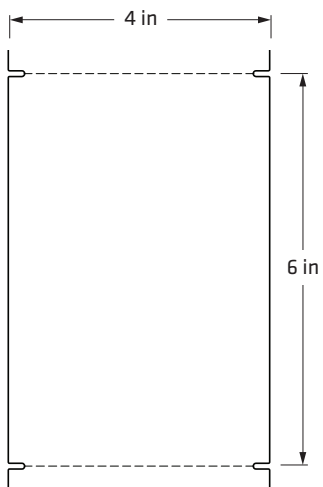

E24458

Size	ID	OD	Part Number	Printer Configuration	Qty/ Roll	Rolls/ Ctn	Ctn Weight	Stock/MTO
4"x6"	.75"	2.6"	E24458	Mobile	140	16	12	MTO

Duratherm II 7-mil Paper Tag

A 7-mil uncoated direct thermal tag that offers high quality, cost effective printing. This material is recommended for most general use applications where exposure to chemicals and moisture is not anticipated.

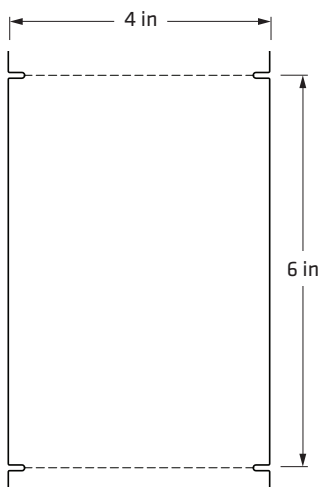

E04633

Size	ID	OD	Part Number	Printer Configuration	Qty/ Roll	Rolls/ Ctn	Ctn Weight	Stock/MTO
4"x6"	3"	8.38"	E04633	Industrial	1,000	4	24	Stock

Desktop



Industrial



Mobile



ThermaMAX 1000 Wax Ribbons

A general-purpose, smear-resistant wax ribbon providing good durability when printing on Duratran™ II Papers and Tags.

Size	Length	Part Number	Qty/Ctn	Printer Configuration	Ctn Weight	Stock/MTO	Printer
2.35"	10800"	11232211	36	Desktop	17 lbs	Stock	PC43, PF8-1"
3.1"	10800"	11233011	24	Desktop	21 lbs	Stock	PC43, PF8-1"
3.27"	3588"	11043304	6	Desktop	4 lbs	Stock	PC43, PF8-0.5"
4.1"	10800"	11234012	6	Desktop	4 lbs	Stock	PC43, PF8-1"
4.33"	3588"	11044304	6	Desktop	6 lbs	Stock	PC43, PF8-0.5"
2.05"	18024"	11232018	36	Industrial	22 lbs	Stock	PM43, PM4i, PX4i, PD41
3"	18024"	11233018	12	Industrial	30 lbs	Stock	PM43, PM4i, PX4i, PD41
4.09"	18024"	11234118	24	Industrial	27 lbs	Stock	PM43, PM4i, PX4i, PD41

ThermaMAX 2000 Mid-Range Ribbons

A mid-range ribbon that provides enhanced abrasion/smear resistance and high image quality when used with Duratran II coated papers and across the Intermec Mid-Range Film product line.

Size	Length	Part Number	Qty/Ctn	Printer Configuration	Ctn Weight	Stock/MTO	Printer
2.35"	10800"	12232311	24	Desktop	9 lbs	Stock	PC43, PF8-1"
2.5"	3588"	12042504	48	Desktop	10 lbs	Stock	PC43, PF8-0.5"
3.15"	10800"	12233111	24	Desktop	10 lbs	Stock	PC43, PF8-1"
3.27"	3588"	12043204	24	Desktop	7 lbs	Stock	PC43, PF8-0.5"
4.1"	10800"	12234012	24	Desktop	19 lbs	Stock	PC43, PF8-1"
4.33"	3588"	12044304	18	Desktop	7 lbs	Stock	PC43, PF8-0.5"
2.05"	18024"	12232018	24	Industrial	22 lbs	Stock	PM43, PM4i, PX4i, PD41
2.99"	18024"	12233018	24	Industrial	30 lbs	Stock	PM43, PM4i, PX4i, PD41
4.09"	18024"	12234118	12	Industrial	13 lbs	Stock	PM43, PM4i, PX4i, PD41

ThermaMAX 3000 Resin Ribbons

A high quality resin ribbon for applications that require the optimum level of smear and abrasion resistance. Excellent imaging and performance across the Intermec Ultra-Durable Film product line.

Size	Length	Part Number	Qty/Ctn	Printer Configuration	Ctn Weight	Stock/MTO	Printer
2.36"	10800"	13632111	24	Desktop	12 lbs	Stock	PC43, PF8-1"
2.5"	3588"	13042504	6	Desktop	4 lbs	Stock	PC43, PF8-0.5"
3.1"	10800"	13633111	24	Desktop	15 lbs	MTO	PC43, PF8-1"
3.1"	3588"	13633136	24	Desktop	7 lbs	MTO	PC43, PF8-0.5"
4.1"	10800"	13634012	24	Desktop	14 lbs	Stock	PC43, PF8-1"
4.33"	3588"	13044304	6	Desktop	6 lbs	Stock	PC43, PF8-0.5"
2.09"	18036"	13632018	24	Industrial	12 lbs	Stock	PM43, PM4i, PX4i, PD41
2.99"	18036"	13633018	24	Industrial	18 lbs	Stock	PM43, PM4i, PX4i, PD41
4.09"	18036"	13634118	24	Industrial	24 lbs	Stock	PM43, PM4i, PX4i, PD41

Desktop



Industrial



Mobile



Duratran S

A 3-mil thick polypropylene thermal transfer label at an attractive price point. The matte face stock offers excellent print quality and moisture resistance; recommended for up to six months outdoor exposure.

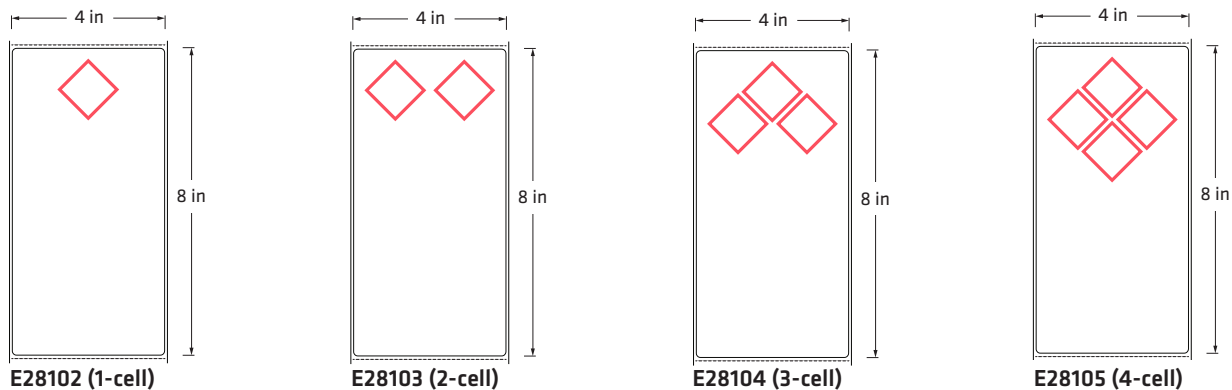

Size	ID	OD	Part Number	Printer Configuration	Qty/ Roll	Rolls/ Ctn	Ctn Weight	Stock/ MTO	PC41/PF8-0.5" Ribbon	PC43t/PF8t-1" Ribbon	PD/PM/PX Ribbon
4"x8"	3"	8.38"	E28102 (1-cell)	Industrial	738	4	28	MTO	n/a	n/a	12234118
4"x8"	3"	8.38"	E28103 (2-cell)	Industrial	738	4	28	MTO	n/a	n/a	12234118
4"x8"	3"	8.38"	E28104 (3-cell)	Industrial	738	4	28	MTO	n/a	n/a	12234118
4"x8"	3"	8.38"	E28105 (4-cell)	Industrial	738	4	28	MTO	n/a	n/a	12234118

Indelible HP (BS5609 / IMDG Compliant)

A high-gloss, top-coated polyester label with exceptional print quality. High performance, heavy coat weight adhesive develops a positive, secure bond even on contaminated or rough surfaces. Excellent tear, smear and abrasion resistance; highly moisture and heat resistant.

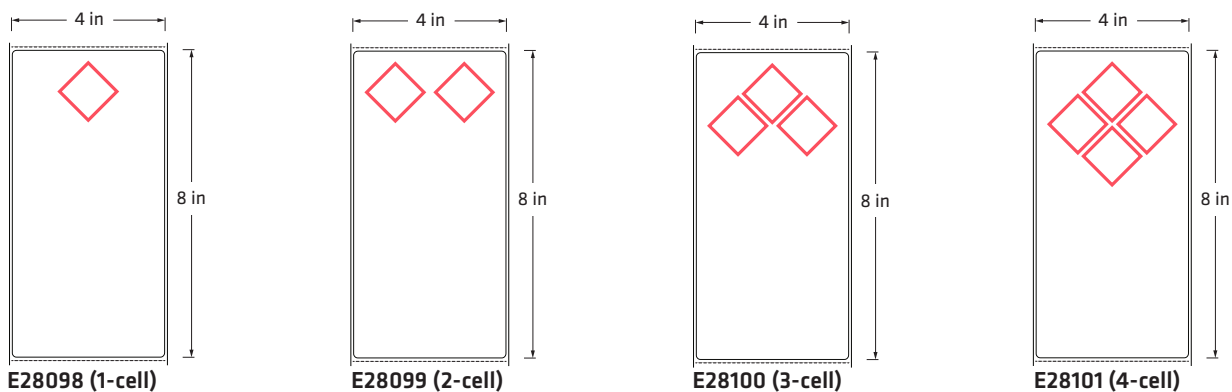

Size	ID	OD	Part Number	Printer Configuration	Qty/ Roll	Rolls/ Ctn	Ctn Weight	Stock/ MTO	PC41/PF8-0.5" Ribbon	PC43t/PF8t-1" Ribbon	PD/PM/PX Ribbon
4"x8"	3"	8.38"	E28098 (1-cell)	Industrial	738	4	28	MTO	n/a	n/a	13634118
4"x8"	3"	8.38"	E28099 (2-cell)	Industrial	738	4	28	MTO	n/a	n/a	13634118
4"x8"	3"	8.38"	E28100 (3-cell)	Industrial	738	4	28	MTO	n/a	n/a	13634118
4"x8"	3"	8.38"	E28101 (4-cell)	Industrial	738	4	28	MTO	n/a	n/a	13634118

Syntran

A durable polyethylene thermal transfer label. Aggressive specialty adhesive provides excellent tamper evidence on most surfaces.

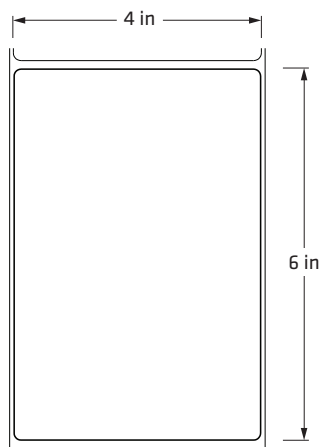

E04222

Size	ID	OD	Part Number	Printer Configuration	Qty/ Roll	Rolls/ Ctn	Ctn Weight	Stock/ MTO	PC41/PF8-0.5" Ribbon	PC43t/PF8t-1" Ribbon	PD/PM/PX Ribbon
4"X6"	3"	8.38"	E04222	Industrial	857	4	25	Stock	n/a	n/a	12234118

Duratran S

A 3-mil thick polypropylene thermal transfer label at an attractive price point. The matte face stock offers excellent print quality and moisture resistance; recommended for up to six months outdoor exposure.

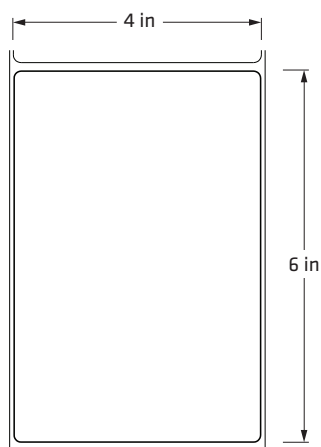

E25743

Size	ID	OD	Part Number	Printer Configuration	Qty/ Roll	Rolls/ Ctn	Ctn Weight	Stock/ MTO	PC41/PF8-0.5" Ribbon	PC43t/PF8t-1" Ribbon	PD/PM/PX Ribbon
4"X6"	3"	8.38"	E25743	Industrial	979	4	23	MTO	n/a	n/a	12234118

Desktop



Industrial



Mobile



INdelible

A high-gloss, top-coated polyester label with exceptional print quality. Excellent tear, smear and abrasion resistance; highly moisture and heat resistant. Product is UL and cUL recognized when printed with Intermec ThermaMAX 3202 ribbons. Also available in clear and silver face stocks. For self-strip applications, 4-mil face stocks are also available.

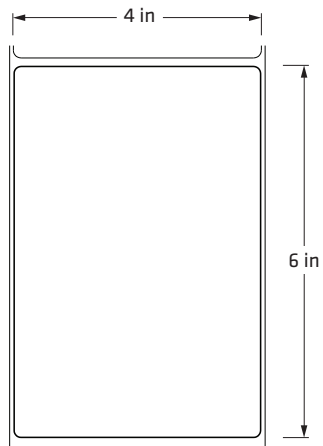

E25733

Size	ID	OD	Part Number	Printer Configuration	Qty/ Roll	Rolls/ Ctn	Ctn Weight	Stock/ MTO	PC41/PF8-0.5" Ribbon	PC43t/PF8t-1" Ribbon	PD/PM/PX Ribbon
4"X6"	3"	8.38"	E25733	Industrial	979	4	27	Stock	n/a	n/a	13634118



Duratran II Label (for paper-based packaging)

A top-coated thermal transfer paper that demonstrates excellent print quality with both the TMX1407 and TMX2202 ribbons. This product is recommended where moderate abrasion, heat or sunlight are present.

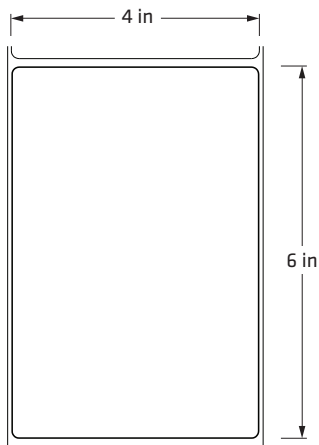

E06175

Size	ID	OD	Part Number	Printer Configuration	Qty/ Roll	Rolls/ Ctn	Ctn Weight	Stock/ MTO	PC41/PF8-0.5" Ribbon	PC43t/PF8t-1" Ribbon	PD/PM/PX Ribbon
4"x6"	3"	8.38"	E06175	Industrial	979	4	22	Stock	n/a	n/a	11234118

Syntran Label (for woven plastic packaging)

A durable polyethylene thermal transfer label. Aggressive specialty adhesive provides excellent tamper evidence on most surfaces.

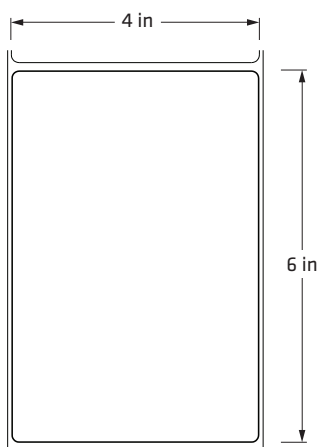

E04222

Size	ID	OD	Part Number	Printer Configuration	Qty/ Roll	Rolls/ Ctn	Ctn Weight	Stock/ MTO	PC41/PF8-0.5" Ribbon	PC43t/PF8t-1" Ribbon	PD/PM/PX Ribbon
4"x6"	3"	8.38"	E04222	Industrial	857	4	25	Stock	n/a	n/a	12234118

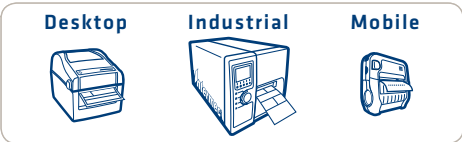

AUTOMOTIVE INDUSTRY APPLICATIONS *Component Labeling*

INdelible

A high-gloss, top-coated polyester label with exceptional print quality. Excellent tear, smear and abrasion resistance; highly moisture and heat resistant. Product is UL and cUL recognized when printed with Intermec ThermaMAX 3202 ribbons. Also available in clear and silver face stocks. For self-strip applications, 4-mil face stocks are also available.

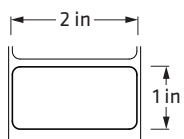

E22233

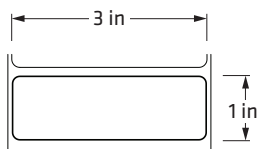

E25746

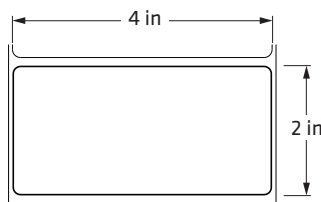

E25747

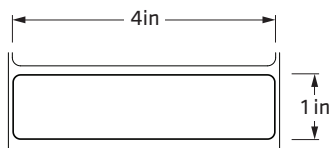

E25732

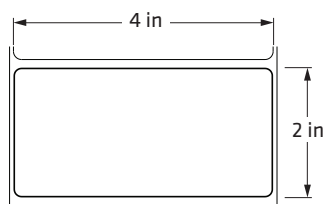

E23222

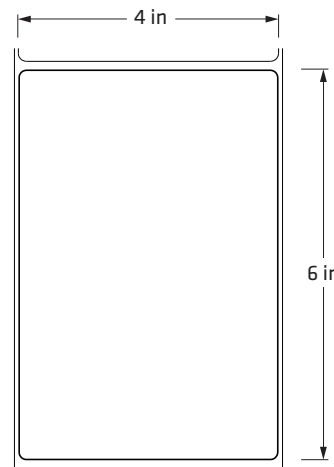

E25733

Size	ID	OD	Part Number	Printer Configuration	Qty/ Roll	Rolls/ Ctn	Ctn Weight	Stock/ MTO	PC41/PF8-0.5" Ribbon	PC43t/PF8t-1" Ribbon	PD/PM/PX Ribbon
2"x1"	1.5"	5"	E22233	Desktop	2,702	8	10	Stock	13042504	13632111	n/a
3"x1"	1.5"	5"	E25746	Desktop	2,702	4	12	Stock	13633136	13633111	n/a
4"x2"	1.5"	5"	E25747	Desktop	2,702	4	12	Stock	13044304	13634012	n/a
4"x1"	3"	8.38"	E25732	Industrial	5,333	4	25	Stock	n/a	n/a	13634118
4"x2"	3"	8.38"	E23222	Industrial	2,823	8	51	Stock	n/a	n/a	13634118
4"x6"	3"	8.38"	E25733	Industrial	979	8	51	Stock	n/a	n/a	13634118

INdelible HP

A high-gloss, top-coated polyester label with exceptional print quality. High performance, heavy coat weight adhesive develops a positive, secure bond even on contaminated or rough surfaces. Excellent tear, smear and abrasion resistance; highly moisture and heat resistant.

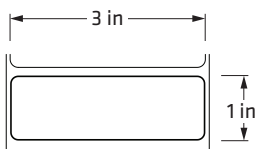

E27277

Size	ID	OD	Part Number	Printer Configuration	Qty/ Roll	Rolls/ Ctn	Ctn Weight	Stock/ MTO	PC41/PF8-0.5" Ribbon	PC43t/PF8t-1" Ribbon	PD/PM/PX Ribbon
3"x1"	3"	8.38"	E27277	Industrial	5333	4	21	Stock	n/a	n/a	13633018

Desktop



Industrial



Mobile



Duratran Pro Tag

A premium performance polyethylene tag with excellent tear resistance. Excellent choice when attaching with thin gauge wire or when staples are used.

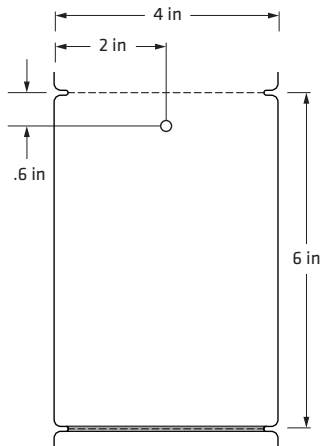

E12982

Size	ID	OD	Part Number	Printer Configuration	Qty/ Roll	Rolls/ Ctn	Ctn Weight	Stock/ MTO	PC41/PF8-0.5" Ribbon	PC43t/PF8t-1" Ribbon	PD/PM/PX Ribbon
4"x6"	3"	8.38"	E12982	Industrial	916	4	23	Stock	n/a	n/a	12234118

Reusable Compliance Totes

Duratran S Tight Removable

A 3 mil thick polypropylene thermal transfer label ideal for use on plastic totes. The matte face stock offers excellent print quality and moisture resistance; tight removable adhesive provides secure adhesion and clean removability. Recommended for up to six months of outdoor exposure.

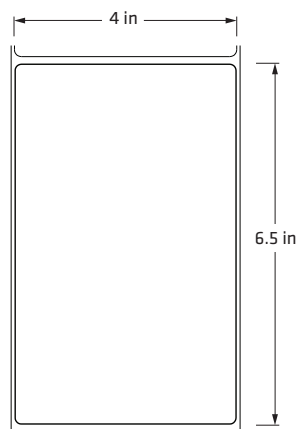

E26362

Size	ID	OD	Part Number	Printer Configuration	Qty/ Roll	Rolls/ Ctn	Ctn Weight	Stock/ MTO	PC41/PF8-0.5" Ribbon	PC43t/PF8t-1" Ribbon	PD/PM/PX Ribbon
4"x6.5"	3"	8.18"	E26362	Industrial	905	8	46	Stock	n/a	n/a	12234118

Desktop



Industrial



Mobile



INdelible Paint Mask

A high-gloss, top-coated piggyback polyester label with exceptional print quality and durability. Using an innovative cut design and piggyback polyester laminate, positive asset identification can be maintained through the painting/coating process.

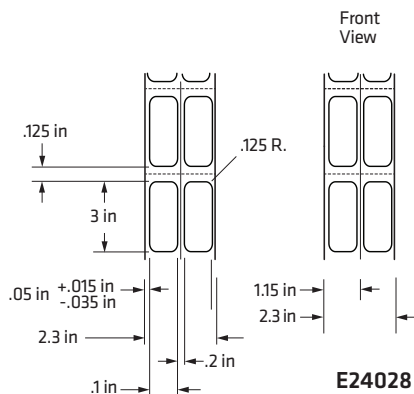

Size	ID	OD	Part Number	Printer Configuration	Qty/ Roll	Rolls/ Ctn	Ctn Weight	Stock/ MTO	PC41/PF8-0.5" Ribbon	PC43t/PF8t-1" Ribbon	PD/PM/PX Ribbon
1"x3"	3"	8.38"	E24028	Industrial	1,600	12	49	Stock	n/a	n/a	13633018

Kanban

Duratran II Tag

A 7-mil paper tag that provides excellent print quality and is recommended for most general-use applications where exposure to chemicals and moisture is not anticipated. This tag is compatible with TMX1407 and TMX2202 ribbons.

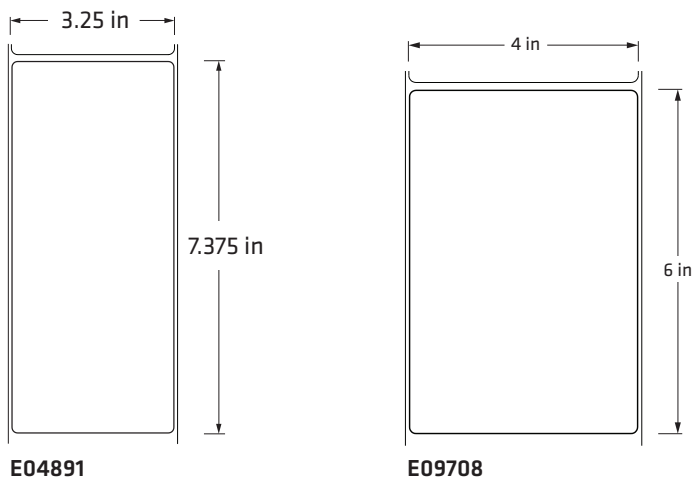

Size	ID	OD	Part Number	Printer Configuration	Qty/ Roll	Rolls/ Ctn	Ctn Weight	Stock/ MTO	PC41/PF8-0.5" Ribbon	PC43t/PF8t-1" Ribbon	PD/PM/PX Ribbon
3.25" x 7.375"	3"	8.38"	E04891	Industrial	813	8	42	Stock	n/a	n/a	11234118
4"x6"	3"	8.38"	E09708	Industrial	1,000	4	26	Stock	n/a	n/a	11234118



AUTOMOTIVE INDUSTRY APPLICATIONS *Kanban*

Duratherm II Tag

A non-top-coated direct thermal paper that offers high quality, cost-effective printing for mobile printing applications. This material is recommended for most general-use applications where exposure to chemicals and moisture is not anticipated.

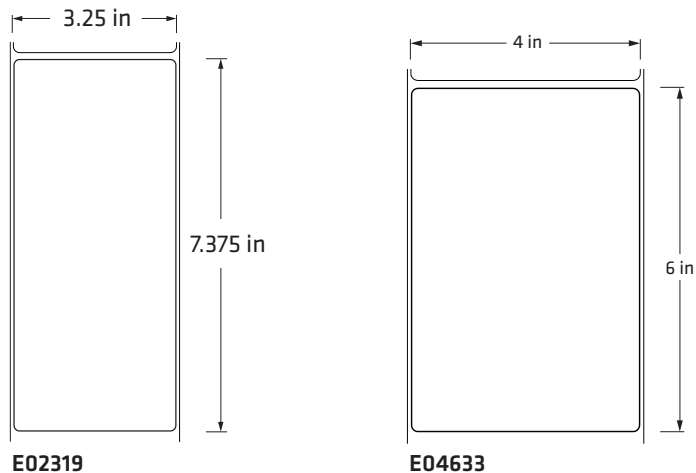

E02319

E04633

Size	ID	OD	Part Number	Printer Configuration	Qty/ Roll	Rolls/ Ctn	Ctn Weight	Stock/ MTO	PC41/PF8-0.5" Ribbon	PC43t/PF8t-1" Ribbon	PD/PM/PX Ribbon
3.25" x 7.375"	3"	8.38"	E02319	Industrial	813	4	21	Stock	n/a	n/a	n/a
4"x6"	3"	8.38"	E04633	Industrial	1,000	4	26	Stock	n/a	n/a	n/a

Flame-Retardant Sew-In

Material

A woven nylon tag stock for sew-in applications such as automotive, aerospace, and durable tagging applications. Meets FMVSS302 specifications.

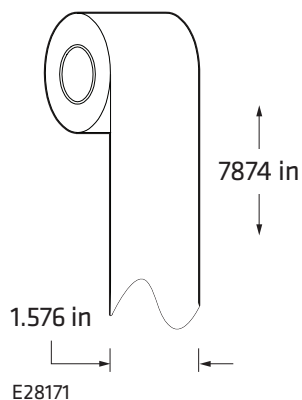

E28171

Size	ID	OD	Part Number	Printer Configuration	Qty/ Roll	Rolls/ Ctn	Ctn Weight	Stock/ MTO	PC41/PF8-0.5" Ribbon	PC43t/PF8t-1" Ribbon	PD/PM/PX Ribbon
1.576" x 7874"	3"	8.38"	E28171	Industrial	Continuous	16	MTO	n/a	n/a	n/a	13632018

Desktop



Industrial



Mobile



INdelible VOID

These products employ a specialty adhesive that cohesively fails when removable is attempted. Since these items are used for product labeling, unique sizes are typically required. Please contact Intermec by Honeywell to receive a quote on your custom-sized label using INdelible VOID.

Syntran

A durable polyethylene thermal transfer label. Aggressive specialty adhesive provides excellent tamper evidence on most surfaces.

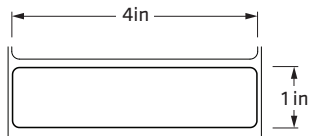

E25744

Size	ID	OD	Part Number	Printer Configuration	Qty/ Roll	Rolls/ Ctn	Ctn Weight	Stock/ MTO	PC41/PF8-0.5" Ribbon	PC43t/PF8t-1" Ribbon	PD/PM/PX Ribbon
4"x1"	3"	8.38"	E25744	Industrial	4666	4	23	MTO	n/a	n/a	12234118

Retail Tire Label

INTact HP

A high-gloss, top-coated white polypropylene label with exceptional print quality. Flexible facesheet ensures good conformability to small diameter vials; aggressive adhesive develops a strong bond with polypropylene and polyethylene vials as well as less challenging plastics, glass, and steel. After room-temperature application, reliably adheres to surfaces frozen to -112F (-80C). Excellent tear, smear and abrasion resistance; compatible with Intermec ThermaMAX 3201 and 3202 ribbons.

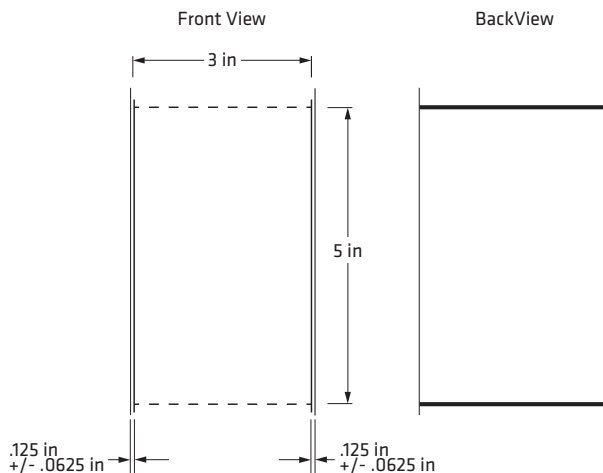

E28172

Size	ID	OD	Part Number	Printer Configuration	Qty/ Roll	Rolls/ Ctn	Ctn Weight	Stock/ MTO	PC41/PF8-0.5" Ribbon	PC43t/PF8t-1" Ribbon	PD/PM/PX Ribbon
3"x5"	3"	8.38"	E28172	Industrial	1,100	8	50	MTO	n/a	n/a	13634118



Top-Side - INdelible

A high-gloss, top-coated polyester label with exceptional print quality. Excellent tear, smear and abrasion resistance; highly moisture and heat resistant. Product is UL and cUL recognized when printed with Intermec ThermaMAX 3202 ribbons. Also available in clear and silver face stocks. For self-strip applications, 4-mil face stocks are also available.

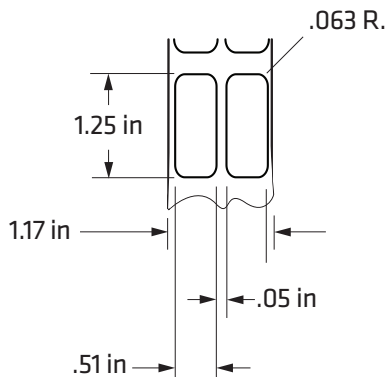

E23066

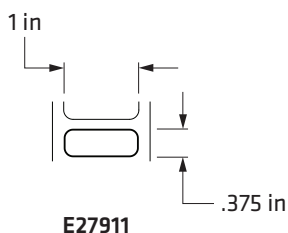

E27911

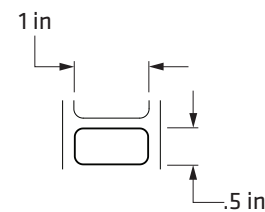

E27912

Size	ID	OD	Part Number	Printer Configuration	Qty/ Roll	Rolls/ Ctn	Ctn Weight	Stock/ MTO	PC41/PF8-0.5" Ribbon	PC43t/PF8t-1" Ribbon	PD/PM/PX Ribbon
0.51"x1.25" (2-up)	3"	6.5"	E23066	Industrial	2130 x 2up	4		Stock	n/a	n/a	13632018
1"x0.375"	3"	8.38"	E27911	Industrial	12,000	4		MTO	n/a	n/a	13632018
1"x0.5"	3"	8.38"	E27912	Industrial	9,600	4		MTO	n/a	n/a	13632018

Wafer Manufacture (Clean Room)

INdelible Clean

A high-gloss, top-coated polyester label with exceptional print quality. Excellent tear, smear and abrasion resistance; highly moisture and heat resistant. Product is UL and cUL recognized when printed with Intermec ThermaMAX 3202 ribbons. Also available in clear and silver face stocks. For self-strip applications, 4-mil face stocks are also available.

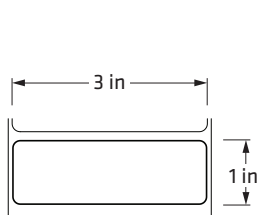

E28190

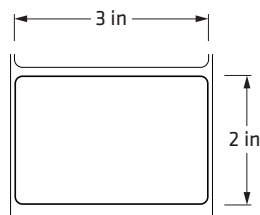

E28191

Size	ID	OD	Part Number	Printer Configuration	Qty/Roll	Rolls/Ctn	Ctn Weight	Stock/MTO	PD/PM/P Ribbon
3"x1"	3"	8.38"	E28190	Industrial	5,333	8	38	MTO	336P4118
3"x2"	3"	8.38"	E28191	Industrial	2,823	8	38	MTO	336P4118



Duratran Clean

A fully synthetic product optimized to reduce potential for particulate contamination. Designed for use in clean room environments.

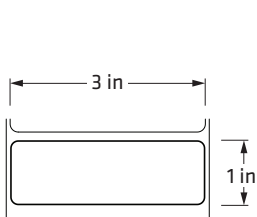

E28192

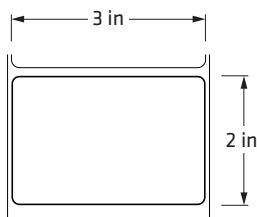

E28193

Size	ID	OD	Part Number	Printer Configuration	Qty/ Roll	Rolls/ Ctn	Ctn Weight	Stock/MTO	PD/PM/P Ribbon
3"x1"	3"	8.38"	E28192	Industrial	5,333	8	12	MTO	336P4118
3"x2"	3"	8.38"	E28193	Industrial	2,823	8	12	MTO	336P4118

Name Plates / Agency Labels

INdelible

A high-gloss, top-coated polyester label with exceptional print quality. Excellent tear, smear and abrasion resistance; highly moisture and heat resistant. Product is UL and cUL recognized when printed with Intermec ThermaMAX 3202 ribbons. Also available in clear and silver face stocks. For self-strip applications, 4-mil face stocks are also available.

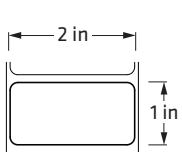

E22233

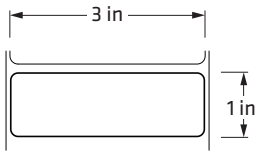

E25746

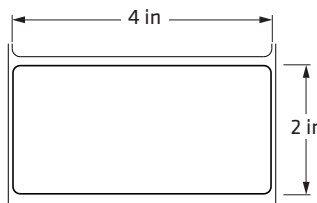

E25747

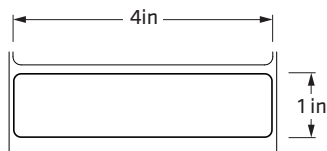

E25732

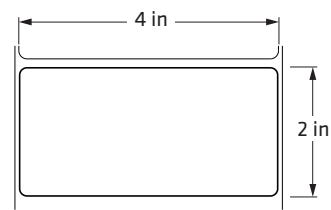

E23222

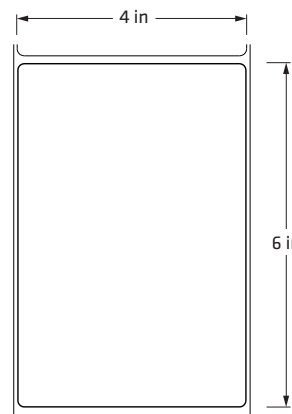

E25733

Size	ID	OD	Part Number	Printer Configuration	Qty/ Roll	Rolls/ Ctn	Ctn Weight	Stock/ MTO	PC41/PF8-0.5" Ribbon	PC43t/PF8t-1" Ribbon	PD/PM/PX Ribbon
2"x1"	1.5"	5"	E22233	Desktop	2,702	8	10	MTO	13042504	13632111	n/a
3"x1"	1.5"	5"	E25746	Desktop	2,702	4	12	Stock	13633136	13633111	n/a
4"x2"	1.5"	5"	E25747	Desktop	1,430	4	12	MTO	13044304	13634012	n/a
4"x1"	3"	8.38"	E25732	Industrial	5,330	4	25	Stock	n/a	n/a	13634118
4"x2"	3"	8.38"	E23222	Industrial	2,823	8	51	Stock	n/a	n/a	13634118
4"x6"	3"	8.38"	E25733	Industrial	979	4	26	Stock	n/a	n/a	13634118

Desktop



Industrial



Mobile



Duratran Synthetic Tag

A matte polyolefin tag with broad application within industrial and outdoor environments. Good tear resistance and outdoor durability.

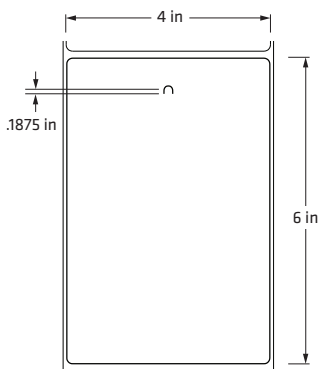

E23895

Size	ID	OD	Part Number	Printer Configuration	Qty/ Roll	Rolls/ Ctn	Ctn Weight	Stock/ MTO	PC41/PF8-0.5" Ribbon	PC43t/PF8t-1" Ribbon	PD/PM/PX Ribbon
4"x6"	3"	8.38"	E23895	Industrial	875	4	26	Stock	n/a	n/a	11234118

Duratran Pro Tag

A premium performance polyethylene tag with excellent tear resistance. Excellent choice when attaching with thin gauge wire or when staples are used.

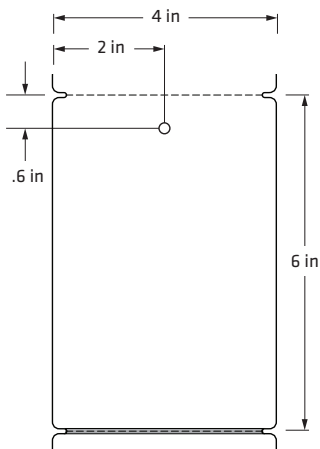

E12982

Size	ID	OD	Part Number	Printer Configuration	Qty/ Roll	Rolls/ Ctn	Ctn Weight	Stock/ MTO	PC41/PF8-0.5" Ribbon	PC43t/PF8t-1" Ribbon	PD/PM/PX Ribbon
4"x6"	3"	8.38"	E12982	Industrial	916	4	23	Stock	n/a	n/a	11234118



INtact Label

A high gloss, top-coated white polypropylene label with exceptional print quality. Flexible facesheet ensures good conformability to small diameter vials; aggressive adhesive develops a strong bond with polypropylene and polyethylene vials as well as less challenging plastics, glass, and steel. After room-temperature application, reliably adheres to surfaces frozen to -112F (-80C). Excellent tear, smear and abrasion resistance; compatible with Intermec ThermaMAX 3202 ribbons.

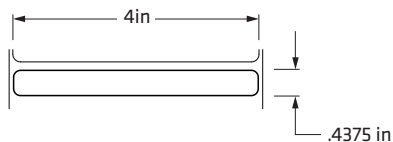

E28187

Size	ID	OD	Part Number	Printer Configuration	Qty/ Roll	Rolls/ Ctn	Ctn Weight	Stock/ MTO	PC41/PF8-0.5" Ribbon	PC43t/PF8t-1" Ribbon	PD/PM/PX Ribbon
4"x0.4375"	3"	8.38"	E28187	Industrial	9,600	4	25	MTO	n/a	n/a	13634118

INdelible Label

A high-gloss, top-coated polyester label with exceptional print quality. Excellent tear, smear and abrasion resistance; highly moisture and heat resistant. Product is UL and cUL recognized when printed with Intermec ThermaMAX 3202 ribbons. Also available in clear and silver face stocks. For self-strip applications, 4-mil face stocks are also available.

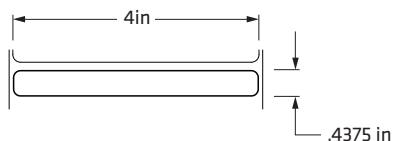

E28188

Size	ID	OD	Part Number	Printer Configuration	Qty/ Roll	Rolls/ Ctn	Ctn Weight	Stock/ MTO	PC41/PF8-0.5" Ribbon	PC43t/PF8t-1" Ribbon	PD/PM/PX Ribbon
4"x0.4375"	3"	8.38"	E28188	Industrial	9,600	4	25	MTO	n/a	n/a	13634118



APPENDIX

Direct Thermal vs. Thermal Transfer

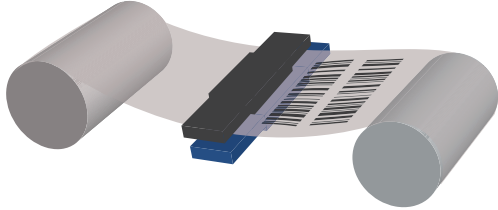

Direct Thermal Media Explained

Direct Thermal media uses a transparent heat-sensitive coating applied to its surface to image text and bar codes. When the heat from the print head contacts the coating, it initiates a chemical reaction that turns the coating black.

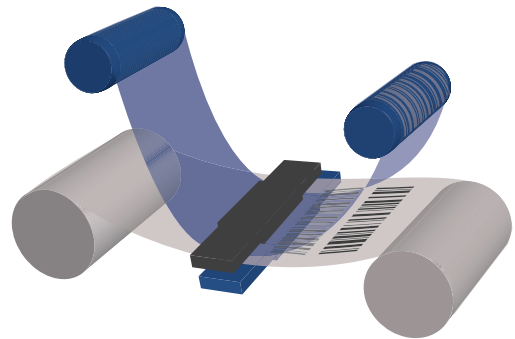

Thermal Transfer Media Explained

Thermal Transfer media uses a ribbon to image the text and bar codes on a variety of materials, both paper and film. When the ribbon is passed beneath the print head, the heat softens the ribbon ink while in contact with the label or tag, resulting in the transfer of the ink to the surface of the label or tag. There are three general classes of ribbons that are used in thermal printers: Wax, Mid-range, and Resin.

Wax ribbons are the most commonly used class and are mostly targeted to print paper labels and tags that will be exposed to relatively benign environments. Wax ribbons are also used to print on film labels and tags in some applications.

Mid-range ribbons are a hybrid design where resin is mixed with the wax to produce ribbons with durability properties that fall somewhere between the wax and resin ribbons. Mid-range ribbons are used to print on both paper and film labels and tags.

Resin ribbons are the most durable and are mostly targeted to printing on film labels and tags that will be exposed to extreme environments.

Free Printhead Replacement Program

The Industry's Most Comprehensive [Printhead Replacement Program](#)

Provides no-cost printhead replacement for all Intermec printers

- Reduces total cost of ownership, speeds up return on investment
- Applies to all Intermec media supplies
- Available globally

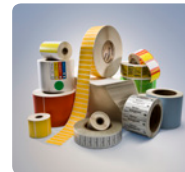
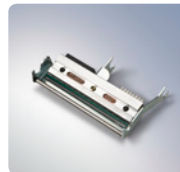

Desktop



Industrial



Mobile



APPENDIX

Application Briefs

Intermec offers a mix of media products to address the requirements of many specific industry applications. Intermec has developed many Applications Brief documents that detail the media performance and regulatory requirements for specific applications for a variety of industries. Below you will find the seven Application Briefs targeted specifically at the Healthcare market.

Anti-Counterfeit RFID Labeling

Counterfeiting is a global phenomenon affecting a wide range of industries. Companies are becoming increasingly aware of the potential negative ramifications of counterfeit parts with altered serial numbers being sourced and distributed in the supplier networks. These substandard parts can escape detection and be deployed in areas such as vehicle and aircraft spare parts and maintenance. Poor product quality, deterioration of the brand, and concern for consumer safety pose a very real threat.

<http://www.intermec.com/public-files/application-briefs/en/ab-Anti-Counterfeit-RFID-Labeling.pdf>



Automotive Manufacturing Labeling

Automotive labeling applications, often requiring adhesion to difficult surfaces and resistance to heat, abrasion and chemicals, can be extremely challenging for conventional labels. Sourcing products to meet these needs requires a label partner with the quality and experience to consistently deliver co-engineered performance.

<http://www.intermec.com/public-files/application-briefs/en/ab-Automotive-Manufacturing-Labeling.pdf>



Automotive Tote Labeling

With lean manufacturing discipline focused on minimizing waste, reducing the environmental impact of operations, and controlling costs, automotive manufacturers have continued to influence their supply chains from disposable containers to reusable totes.

<http://www.intermec.com/public-files/application-briefs/en/ab-automotive-tote.pdf>



Cold Chain Labeling

The cold chain industry faces a standard set of challenges to improve efficiencies, optimize inventory turns, and maintain profitability in a highly competitive environment. However, these are supplemented with increasingly stringent government regulations, the requirement to maintain a highly consistent controlled environment across all four seasons, and the need to document flawless performance when managing sensitive products such as perishable food and pharmaceuticals environment across all four seasons, and the need to document flawless performance when managing sensitive products such as perishable food and pharmaceuticals.

<http://www.intermec.com/public-files/application-briefs/en/ab-Cold-Chain-App-Brief.pdf>



Cold Chain Pharmaceutical Labeling

When managing sensitive pharmaceutical and biologic products, the cold chain industry faces increasingly stringent government regulations, the requirement to maintain a highly consistent controlled environment across all four seasons, and the need to document flawless performance.

<http://www.intermec.com/public-files/application-briefs/en/ab-Cold-Chain-Pharmaceutical-App-Brief.pdf>



APPENDIX

Application Briefs (continued)

IID Item Unique Identification

In October 2008, the US Department of Defense published version 2 of the UID (Unique Identification) guidelines requiring a broad range of assets to be marked with a 2 dimensional data matrix code that is unique at the item level. With an extreme assortment of surfaces and durability requirements, finding a product to reliably track these items can pose a significant challenge. Intermec's comprehensive UID media offering simplifies this daunting task with proven labeling solutions.

http://www.intermec.com/public-files/application-briefs/en/ab_media_iuid_web.pdf



Location Labeling the Warehouse

Bar coding is a critical component in achieving accuracy and efficiency in a warehouse environment. By using bar codes and data collection hardware, businesses can avoid the reduced efficiency and misplaced product costs associated with warehouse management systems reliant on manually keyed data. Whether installing a new warehouse or retrofitting an existing one, proper labeling of the warehouse using an intuitive and logical structure can reduce time spent picking orders while improving inventory location accuracy. A well designed layout can also help new employees quickly learn the warehouse layout.

<http://www.intermec.com/public-files/application-briefs/en/ab-Location-Labeling-the-Warehouse.pdf>



Metal Products Tracking

The metal manufacturing industry has a number of unique challenges in tracking products. With significant inventories of high value items, accurately identifying products (often by multiple factors such as dimensions, grade, processing and finishing conditions) is critical. However, harsh processing and storage environments place significant stresses on labeling and tagging media, undermining the integrity of product identification. Without functional product marking, companies cannot realize the compelling accuracy and efficiency improvements that auto-ID technologies offer.

<http://www.intermec.com/public-files/application-briefs/en/ab-Metal-Products-Tracking.pdf>



Mobile Labeling for Warehouse/Manufacturing Facility

Bar coding is a critical component in maintaining accuracy and efficiency in a warehouse environment. Shipping, receiving, and cross docking, picking and packing, shelf labeling, and tote labeling applications are integral to successful operations. Increasingly, companies are leveraging mobile labeling solutions in these applications. By enabling workers to print labels at the point of activity, mobile solutions enable a more flexible workflow, increased productivity and fewer errors. Intermec's integrated mobile printer and Duratherm media products deliver a comprehensive array of choices to meet these needs.

http://www.intermec.com/public-files/application-briefs/en/ab_Mobile-Labeling-Whrs-or-Mfg-Facility.pdf



Pharma/Biotech Tracking

The Health Industry Business Communications Council and the American National Standards Institute have developed the ANSI/HIBC standards for packed and item level bar coding for the health care industry. Bar code technology is a proven valuable tool for reducing labor costs, human error and automating data to improve the quality of patient care. Standards for proper identification can be found at <http://www.hibcc.org>. Analytical diagnosis begins with specimen analysis in laboratories that submit samples to extreme conditions such as centrifugal separation, cryogenic freezing or autoclave sterilization.

http://www.intermec.com/public-files/application-briefs/en/ab_media_pharma_biotech_tracking_web.pdf



Application Briefs (continued)

Pharmacy Pill Bottle Labeling

Advancements in pharmaceutical science enable improved health, better management of medical conditions, and even extended life spans for many. However, realization of these benefits relies on accurate identification of medicines and dosing instructions; mistakes can have severe health repercussions. Specialized pill bottle labels fulfill this critical identification and information role.

http://www.intermec.com/public-files/application-briefs/en/ab_media_PillBottleLabeling_web.pdf



Printable Paint Mask Labeling

Traceability is increasingly important for today's manufacturers. But in many industrial applications, the manufacturing process requires positive item tracking through a painting process that is incompatible with typical identification methods. Intermec's printable paint mask label solves this challenge, enabling companies to easily track parts through the complete manufacturing process and fully realize the benefits of automatic identification.

http://www.intermec.com/public-files/application-briefs/en/ab_Printable-Paint-Mask-Labeling.pdf



REACH and GHS Chemical Container Labeling

Because of the potentially hazardous nature of chemical products, comprehensive regulations have recently been implemented to improve the margin of safety for human health and the environment. Increasingly global in scope, this drive is intended to replace a patchwork of inconsistent practices around the world, ensuring clear communication of potential hazards and recommended handling procedures regardless of geography and borders. Intermec's chemical container labeling solution set enables this critical messaging function while satisfying international regulations for marking durability and design consistency.

http://www.intermec.com/public-files/application-briefs/en/ab_media_REACH_GHS_Labeling_web.pdf



RFID Smart Labels for Reusable Container Management

Throughout many industries goods are moved from numerous points within the supply chain in what has been intended to be a "returnable/reusable" container. While the expectation is that these containers will be returned and accurately accounted for, the reality can be quite different.

<http://www.intermec.com/public-files/application-briefs/en/ab-RFID-Totes.pdf>



Sew in Law Label

Consumers have become quite familiar with the sight of law labels attached to their mattresses, pillows and other household items. Most of them will never question these products designed to inform and protect them. However, manufacturers know they must attach a durable, legible tag or run afoul of the law, risking costly penalties and manufacturing delays. Tested and approved by IABFLO1 representatives, Intermec's Duratran II Synthetic tag provides an excellent product choice for sew-in law label applications.

http://www.intermec.com/public-files/application-briefs/en/ab_media_sew-in_web.pdf



Application Briefs (continued)

Traceability Labeling for Food Manufacturing

When the Food Safety Modernization Act (FSMA) was signed into law on January 4, 2011, it signaled intent for the FDA to transition from contamination response to prevention. As the broad-reaching changes are fully implemented, they will include requirements for food facilities to proactively integrate plans for corrective action. An effective traceability system provides a foundational element for compliance with impending mandates. Additionally, without an effective traceability system, the negative impact of a potential recall is multiplied.

<http://www.intermec.com/public-files/application-briefs/en/ab-foodlabeling.pdf>



UL Recognized Component Labeling

Some consumers may think that UL only tests finished goods, but the company also tests and verifies a wide range of materials and components that are used to manufacture recognizable products. UL label testing measures characteristics such as print durability, service temperatures, acceptable application surfaces, and chemical resistance; these tests verify that the label will remain securely affixed and readable for the life of a product.

http://www.intermec.com/public-files/application-briefs/en/ab_media_UL_web.pdf



North America

6001 36th Avenue West
Everett, Washington 98203
Phone: (425) 348 2600
Fax: (425) 355 9551

North Latin America

Mexico
Phone: (+52) 55 52 41 48 00
Toll Free NOLA:
01800 490 4990

South Latin America

Brazil
Phone: (+55) 11 3711 6770
Fax: (+55) 11 5502 6780

Europe, Middle East & Africa

Reading, United Kingdom
Phone: (+44) 118 923 0800
Fax: (+44) 118 923 0801

Asia Pacific

Singapore
Phone: (+65) 6303 2100
Fax: (+65) 6303 2199

Media Sales

EMEA: (+31) 24 372 3167
USA: (513) 874 5882
<http://intermec.custhelp.com>

Sales

Toll Free NA: (800) 934 3163
Toll in NA: (425) 348 2726
Freephone ROW:
00800 4488 8844

OEM Sales

Phone: (425) 348 2762

Customer Service & Support

Toll Free NA: (800) 755 5505
Toll in NA: (425) 356 1799
EMEA: intermec.custhelp.com

Internet

www.intermec.com

Worldwide Locations

www.intermec.com/locations